

OCEANLINK 7 MARINE DISPLAY

USER MANUAL

rev. AF



EN

DE

IT

FR

ES

TABLE OF CONTENTS

INTRODUCTION	3	Fuel Level Sensor Calibration	31
Architecture	3	Other Sensors' Calibration	31
SAFETY INFORMATION	4	Custom Sensors Configuration	32
INSTALLATION	6	Default Calibrations	33
Before the Assembly	6	Adjusting the Speed Correction Factor	33
Panel Mounting	7	ALARMS	34
ELECTRICAL CONNECTIONS	9	Alarms Menu Structure	34
Engine Connector [A]	9	Alarms Notification	34
Engine Connector [B]	10	Acknowledge an Alarm	35
EasyLink Connectors [C]	10	Active Alarms	35
NMEA 2000® Connector [D]	11	Configure a Local Alarm	36
Video Input Connector [E]	11	Configure a CAN Alarm	37
Electrical Schematic	12	TROUBLESHOOTING	38
RPM Sensor Connection	13	TECHNICAL DATA	39
Resistive Sensor Connection	14	General Feature	39
External Buzzer Connection (B1)	14	Environmental Features	39
Day / Night Mode Selector Switch (S1)	14	Electrical Features	39
GETTING STARTED	15	Compliance	40
Operation	15	Supported NMEA 2000 Messages	40
Priority of Received Signals	15	Disposal Responsibility	40
Switching ON and OFF	15	SPARE PARTS AND ACCESSORIES	41
Button Functions	15		
Calibration Wizard	16		
Startup Checklist	16		
Upload a Custom Splash Logo	16		
DATA SCREENS	17		
Screens Scrolling	17		
Screen Layouts	17		
Supported Data	19		
Engine Hours	20		
Distance Traveled	21		
NavDash Layout	21		
SCREEN CONFIGURATION	22		
SYSTEM SETTINGS	24		
System Config Structure	24		
Operating the System Config Menu	25		
Units	27		
Change the Brightness of the Display	27		
SAE J1939 Gateway	27		
SENSORS' CONFIGURATIONS	28		
System Config Structure	28		
Configure a Sensor Connected to the Display	29		

INTRODUCTION

OceanLink Master 7" is a multifunction display that lets you monitor engines and related sensor parameters. Up to four engines can be connected to the display.

The integrated NMEA 2000 gateway lets you acquire engine data also via analog sensors or SAE J1939, to then convert and distribute them on the NMEA 2000 network.

The display manages up to six resistive sensors, three voltage sensors and one digital alarm.

All data are also distributed on two EasyLink channels to a maximum of 16 52mm OceanLink gauges per channel.

NMEA 2000 connectivity lets you view navigation data from other devices on the network, such as wind, compass, GPS, speed, and depth data.



ARCHITECTURE

Following is an example of an application with two displays, one used as a gateway and the other as a NMEA 2000 monitor.

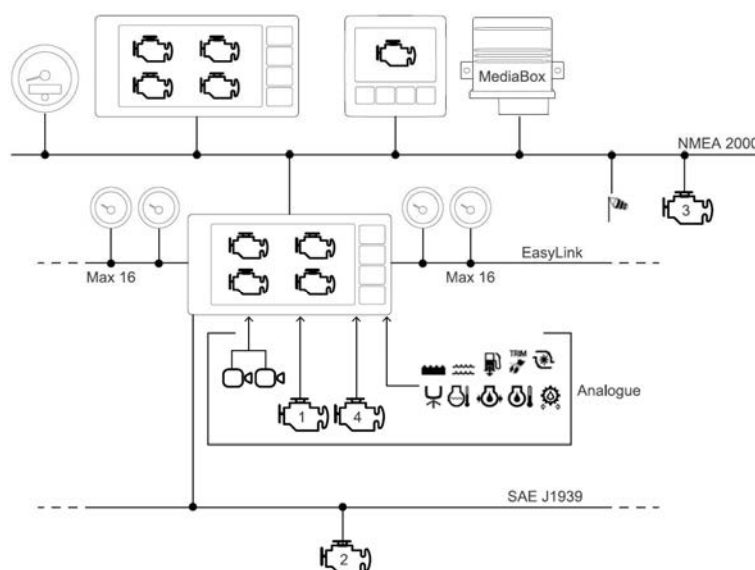

SAFETY INFORMATION

WARNING

- No smoking! No open fire or heat sources!

- The product was developed, manufactured and inspected according to the basic safety requirements of EC Guidelines and state-of-the-art technology.
- The instrument is designed for use in grounded vehicles and machines as well as in pleasure boats, including non-classified commercial shipping.
- Use our product only as intended. Use of the product for reasons other than its intended use may lead to personal injury, property damage or environmental damage. Before installation, check the vehicle documentation for vehicle type and any possible special features!
- Use the assembly plan to learn the location of the fuel/hydraulic/compressed air and electrical lines!
- Note possible modifications to the vehicle, which must be considered during installation!
- To prevent personal injury, property damage or environmental damage, basic knowledge of motor vehicle/shipbuilding electronics and mechanics is required.
- Make sure that the engine cannot start unintentionally during installation!
- Modifications or manipulations to veratron products can affect safety. Consequently, you may not modify or manipulate the product!
- When removing/installing seats, covers, etc., ensure that lines are not damaged and plug-in connections are not loosened!
- Note all data from other installed instruments with volatile electronic memories.

SAFETY DURING INSTALLATION

- During installation, ensure that the product's components do not affect or limit vehicle functions. Avoid damaging these components!
- Only install undamaged parts in a vehicle!
- During installation, ensure that the product does not impair the field of vision and that it cannot impact the driver's or passenger's head!
- A specialized technician should install the product. If you install the product yourself, wear appropriate work clothing. Do not wear loose clothing, as it may get caught in moving parts. Protect long hair with a hair net.
- When working on the on-board electronics, do not wear metallic or conductive jewelry such as necklaces, bracelets, rings, etc.
- If work on a running engine is required, exercise extreme caution. Wear only appropriate work clothing as you are at risk of personal injury, resulting from being crushed or burned.
- Before beginning, disconnect the negative terminal on the battery, otherwise you risk a short circuit. If the vehicle is supplied by auxiliary batteries, you must also disconnect the negative terminals on these batteries! Short circuits can cause fires, battery explosions and damages to other electronic systems. Please note that when you disconnect the battery, all volatile electronic memories lose their input values and must be reprogrammed.
- If working on gasoline boat motors, let the motor compartment fan run before beginning work.
- Pay attention to how lines and cable harnesses are laid so that you do not drill or saw through them!
- Do not install the product in the mechanical and electrical airbag area!
- Do not drill holes or ports in load-bearing or stabilizing stays or tie bars!
- When working underneath the vehicle, secure it according to the specifications from the vehicle manufacturer.
- Note the necessary clearance behind the drill hole or port at the installation location. Required mounting depth: 65 mm.

SAFETY INFORMATION

- Drill small ports; enlarge and complete them, if necessary, using taper milling tools, saber saws, keyhole saws or files. Deburr edges. Follow the safety instructions of the tool manufacturer.
- Use only insulated tools, if work is necessary on live parts.
- Use only the multimeter or diode test lamps provided, to measure voltages and currents in the vehicle/machine or boat. Use of conventional test lamps can cause damage to control units or other electronic systems.
- The electrical indicator outputs and cables connected to them must be protected from direct contact and damage. The cables in use must have enough insulation and electric strength and the contact points must be safe from touch.
- Use appropriate measures to also protect the electrically conductive parts on the connected consumer from direct contact. Laying metallic, uninsulated cables and contacts is prohibited.

SAFETY AFTER INSTALLATION

- Connect the ground cable tightly to the negative terminal of the battery.
- Reenter/reprogram the volatile electronic memory values.
- Check all functions.
- Use only clean water to clean the components. Note the Ingress Protection (IP) ratings (IEC 60529).

ELECTRICAL CONNECTION

- Note cable cross-sectional area!
- Reducing the cable cross-sectional area leads to higher current density, which can cause the cable cross-sectional area in question to heat up!
- When installing electrical cables, use the provided cable ducts and harnesses; however, do not run cables parallel to ignition cables or to cables that lead to large electricity consumers.
- Fasten cables with cable ties or adhesive tape. Do not run cables over moving parts. Do not attach cables to the steering column!
- Ensure that cables are not subject to tensile, compressive or shearing forces.
- If cables are run through drill holes, protect them using rubber sleeves or the like.
- Use only one cable stripper to strip the cable. Adjust the stripper so that stranded wires are not damaged or separated.
- Use only a soft soldering process or commercially available crimp connector to solder new cable connections!
- Make crimp connections with cable crimping pliers only. Follow the safety instructions of the tool manufacturer.
- Insulate exposed stranded wires to prevent short circuits.
- Caution: Risk of short circuit if junctions are faulty or cables are damaged.
- Short circuits in the vehicle network can cause fires, battery explosions and damages to other electronic systems. Consequently, all power supply cable connections must be provided with weldable connectors and be sufficiently insulated.
- Ensure ground connections are sound.
- Faulty connections can cause short circuits. Only connect cables according to the electrical wiring diagram.
- If operating the instrument on power supply units, note that the power supply unit must be stabilized and it must comply with the following standard: DIN EN 61000, Parts 6-1 to 6-4.

INSTALLATION

⚠ WARNING

Before starting work, disconnect the negative terminal of the battery to avoid the risk of a short circuit. If the vehicle is equipped with additional batteries, the negative terminal of all batteries must also be disconnected if necessary. Short circuits can burn cables, explode batteries and cause damage to other electronic systems. Remember that by disconnecting the battery, all data entered in the temporary electronic memory will be lost and will have to be reprogrammed.

BEFORE THE ASSEMBLY

1. Before starting work, switch off the ignition and remove the ignition key. If necessary, remove the main power switch.

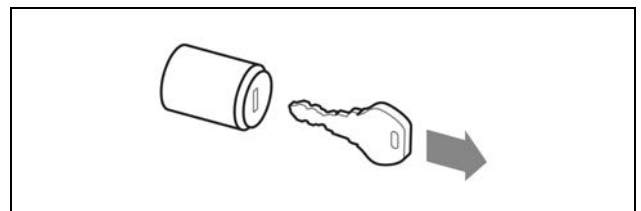

2. Disconnect the negative terminal of the battery. Do not allow the battery to be reconnected by mistake.

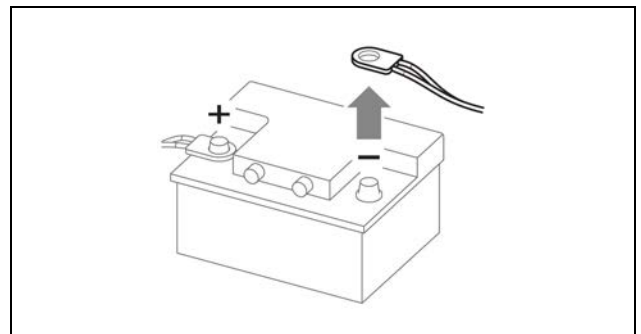

3. When mounting the device in the vicinity of a magnetic compass, maintain a protective distance from the compass.

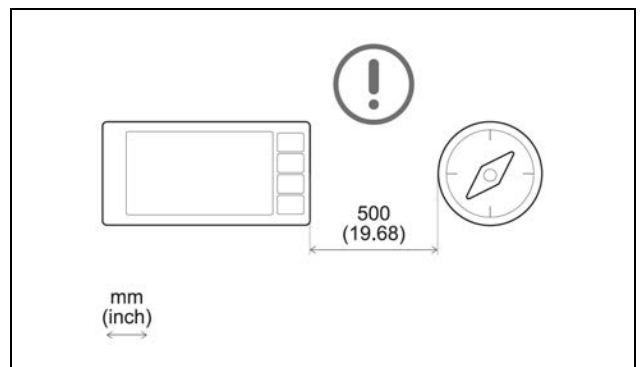

4. Purchase an NMEA 2000 drop cable with five-pin M12 connector (max drop cable length 6 m) and a video cable with a compatible four-pin M12 connector (A2C1845710001).

PANEL MOUNTING

⚠ WARNING

- Do not drill holes or installation openings in supporting or stabilizing beams!
- The mounting location must have sufficient clearance behind the mounting holes or openings.
- Drill small holes with the drill, if necessary, enlarge them using a conical cutter, scroll saw, tail saw or file and finish them. Deburr the edges. It is essential to observe the safety instructions of the tool manufacturer.

1. If installed, remove the bezel.
2. Drill a hole in the panel using the drilling template (see next page of this document) and considering the device dimensions [A].
3. Thread the cables through the hole and connect the connectors.

NOTE: screw in M12 connectors with care. If they screw with difficulty, remove and screw them back in.

4. Insert the device from the front and tighten the four screws [B].
5. Remove the protection film from the display and make sure it is clean and dry.
6. Install the bezel with the sun cover [C].

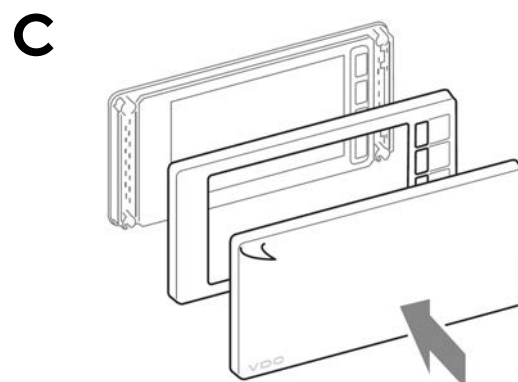
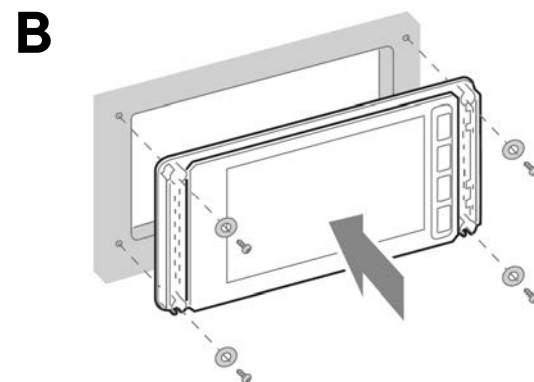
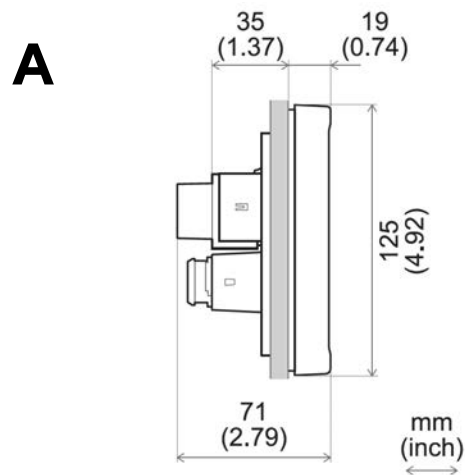

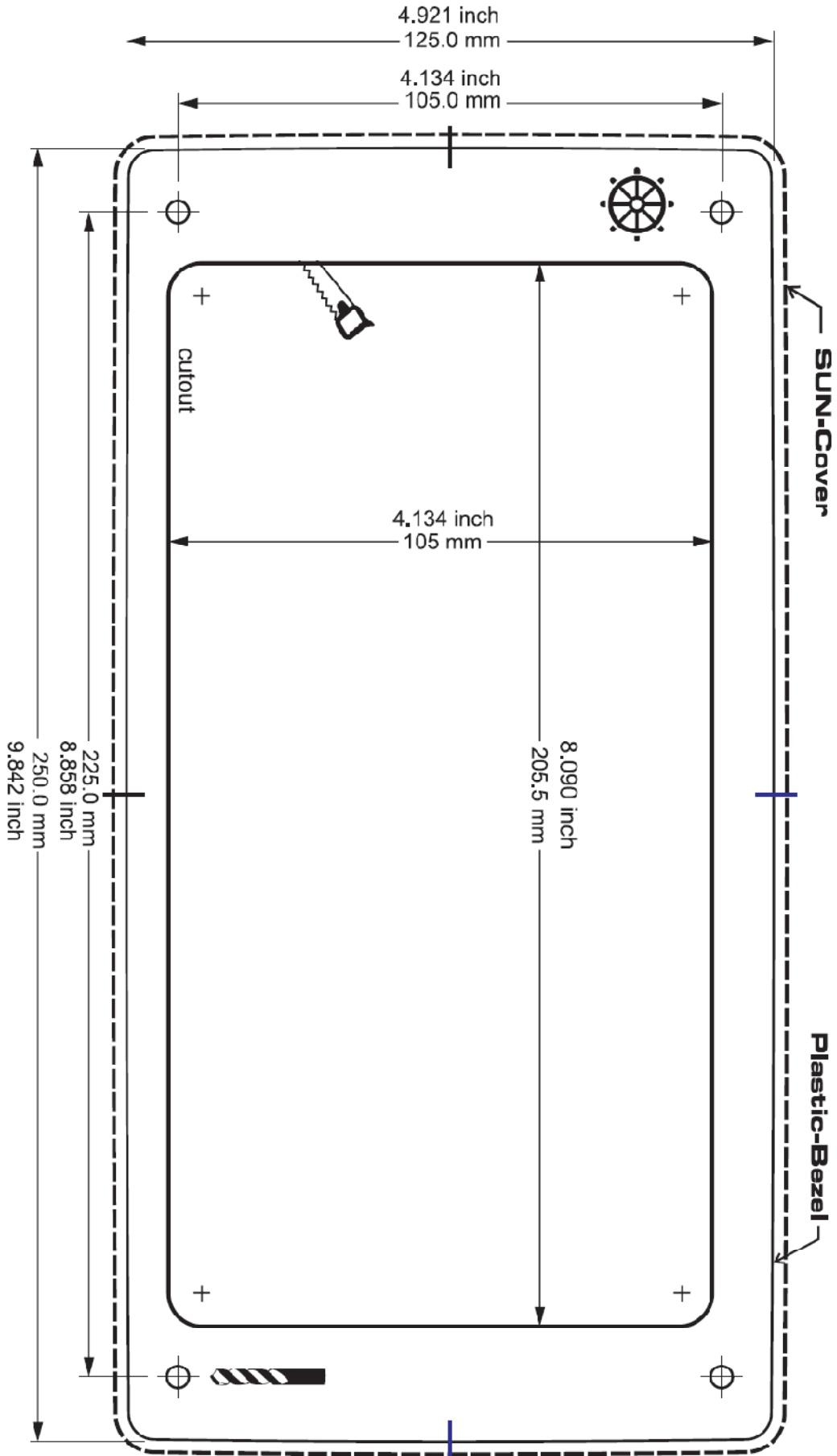

ELECTRICAL CONNECTIONS

⚠ WARNING

- Refer to the safety rules described in the electrical connections section of the safety information chapter of this document!

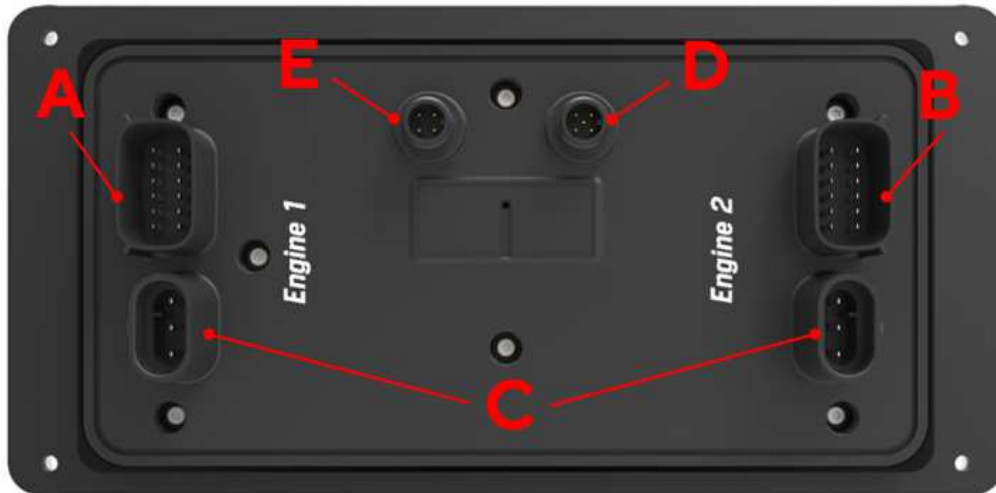

ENGINE CONNECTOR [A]

Pin No.	Wire color	Description
1	Red	KL. 30 - Battery power 12 / 24 V
2	Black	KL. 31 - Ground
3	White	Alarm output
4	Green	Frequency sensor signal - RPM
5	Blue	SAE J1939 - CAN Low
6	Blue / White	SAE J1939 - CAN High
7	Yellow	KL. 15 - Ignition positive
8	Grey	Resistive sensor input
9	Brown	Resistive sensor input
10	Orange	0-5 V sensor input
11	Light Blue	4-20 mA sensor input
12	Violet	4-20 mA sensor input

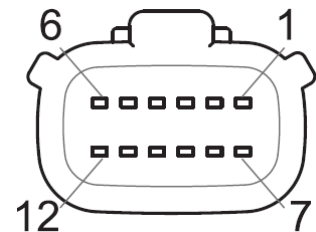

Molex MX150 12-poles connector, cable view
and wire harness A2C1507870001
(included)

ENGINE CONNECTOR [B]

Pin No.	Wire color	Description
1	Pink	Configurable alarm input
2	Black	KL. 31 - Ground
3	White	Alarm output
4	Green	Frequency sensor signal - RPM
5	Blue	SAE J1939 - CAN Low
6	Blue / White	SAE J1939 - CAN High
7	Yellow	0-5 V sensor input
8	Grey	Resistive sensor input
9	Brown	Resistive sensor input
10	Orange	0-5 V sensor input
11	Light Blue	Resistive sensor input
12	Violet	Resistive sensor input

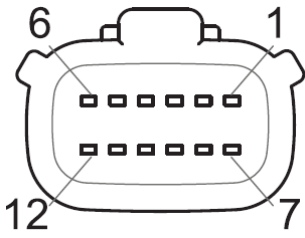

Molex MX150 12-poles connector, cable view and wire harness A2C1507870001 (included)

EASYLINK CONNECTORS [C]

Pin No.	Description
1	12V Power
2	EasyLink Data
3	GND



AMP SuperSeal 1.5 3 poles plug female, cable view

The EasyLink interface is meant for connecting OceanLink 52mm satellites. It is possible to connect up to 16 gauges per channel (daisy-chain) as shown in the picture on the right.

Each channel can display the data from one engine. The engine displayed can be configured in System Config > EasyLink.

VMH satellites are not supported.

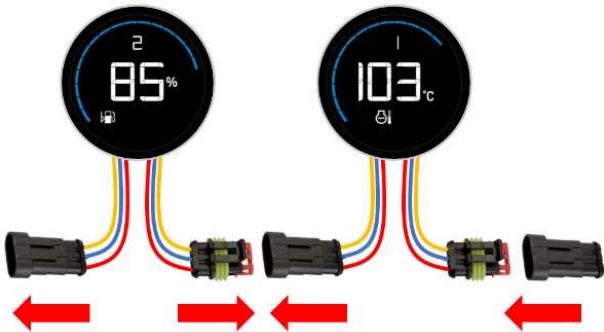

NMEA 2000® CONNECTOR [D]

Pin No.	Description
1	Shield
2	NET-S (V+)
3	NET-C (V-)
4	NET-H (CAN H)
5	NET-L (CAN L)

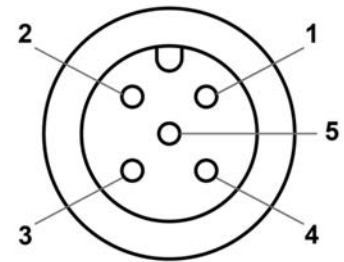

Micro-C M12 5 poles plug male, cable view

Once the installation is complete, you can interface the device to the NMEA 2000® network through the dedicated connector [D].

Be sure to tighten the M12 connector by screwing it onto its counterpart in order to preserve its watertightness.

An accessory drop cable is required. (Not included)

Note that NMEA 2000® does not allow drop cables longer than 6 meters.

Refer to the NMEA 2000® standard for proper network design.



VIDEO INPUT CONNECTOR [E]

Pin No.	Description
1	Video input 2
2	Video input 1
3	GND 2
4	GND 1

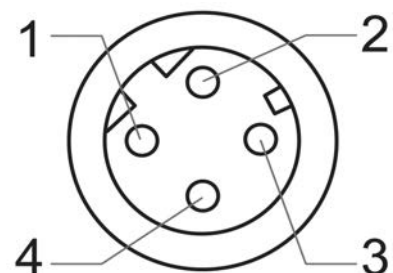

M12 4 poles plug female, cable view

ELECTRICAL SCHEMATIC

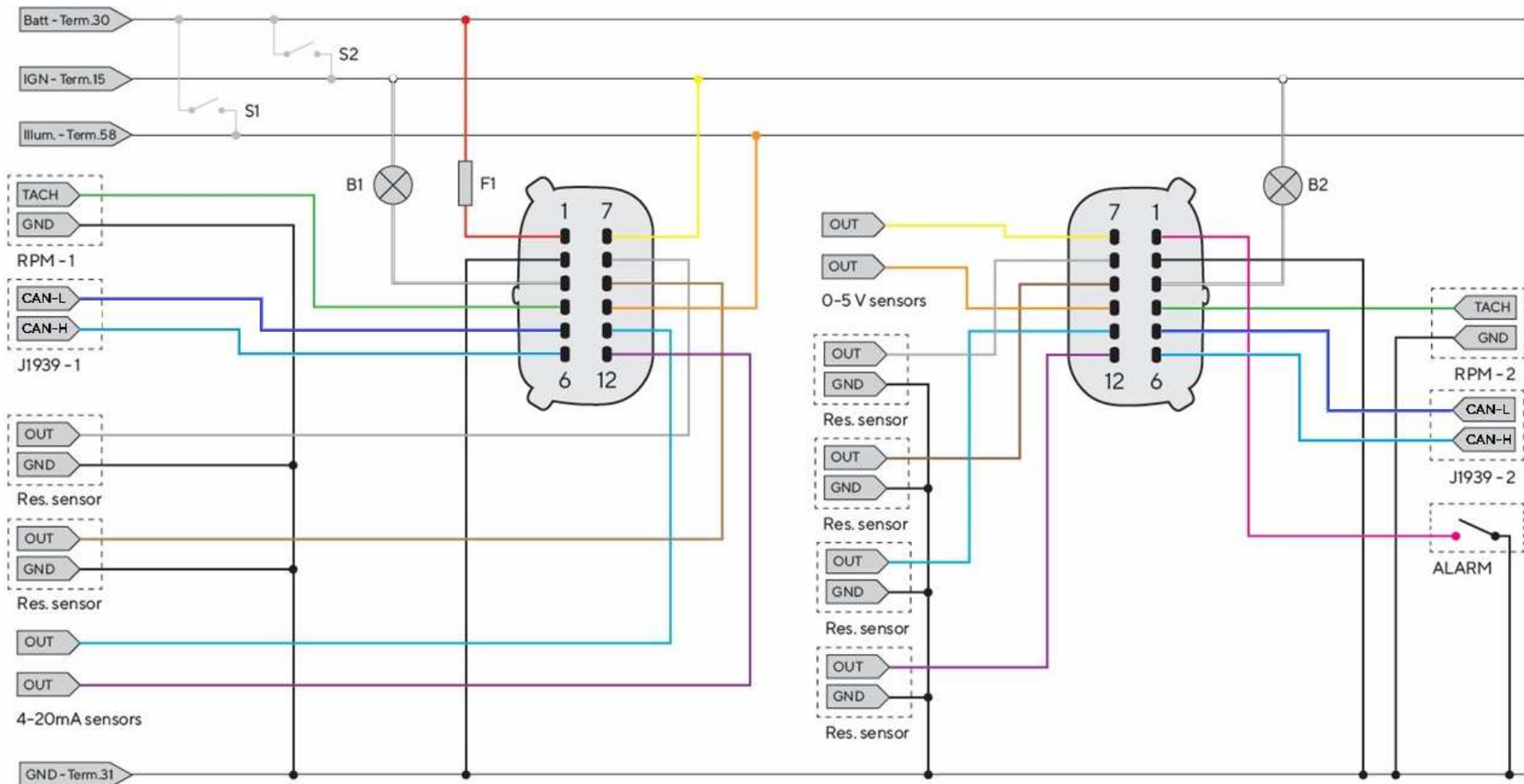

Designations in the circuit diagram

Batt - Term.30 - Battery Power 12/24 V
IGN - Term. 15 - Ignition positive
GND - Term. 31 - Ground
Illum. - Term.58 - Illumination positive

S1 - Day/Night mode switch (not included)
S2 - Ignition key
F1 - 3A fuse (not included)
B1/B2 - External acoustic alarm (not included)

RES - Resistive inputs
RPM - Frequency inputs
ALARM - External digital alarm
J1939 - SAE J1939 CAN ports

RPM SENSOR CONNECTION

The engine RPM signal can be obtained from different sources, respectively the alternator "W" terminal, the ignition coil terminal "1", or from dedicated sensors such as a generator or an inductive sensor. It is advisable to use sensors with isolated ground, and it is necessary to ensure that the sensor ground is connected to the display ground to avoid incorrect readings.

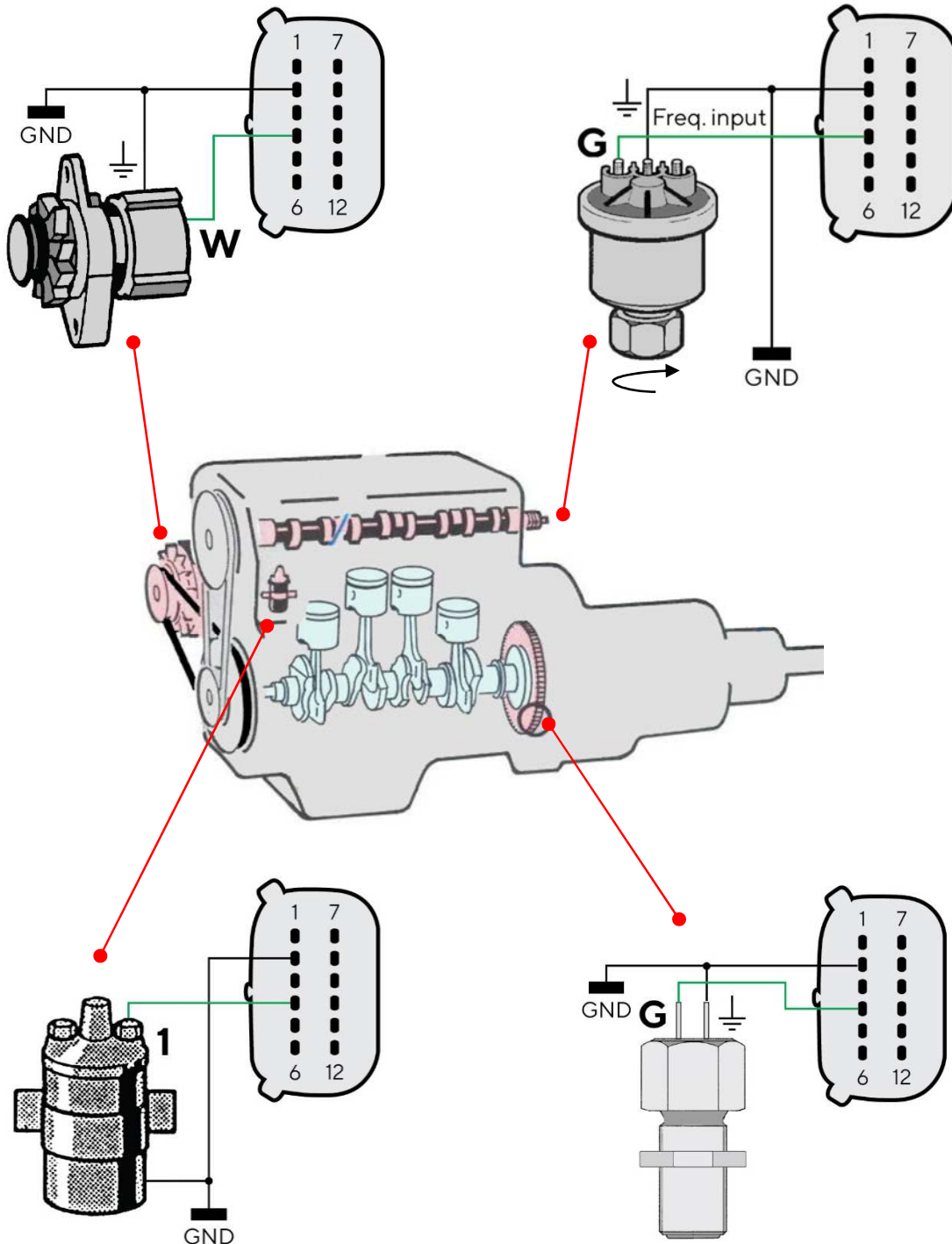

RESISTIVE SENSOR CONNECTION

Any sensor connected to a resistive input of the display must be connected as shown in the figure. It is advisable to use sensors with isolated ground, and it is necessary to ensure that the sensor ground is connected to the display ground to avoid incorrect readings.

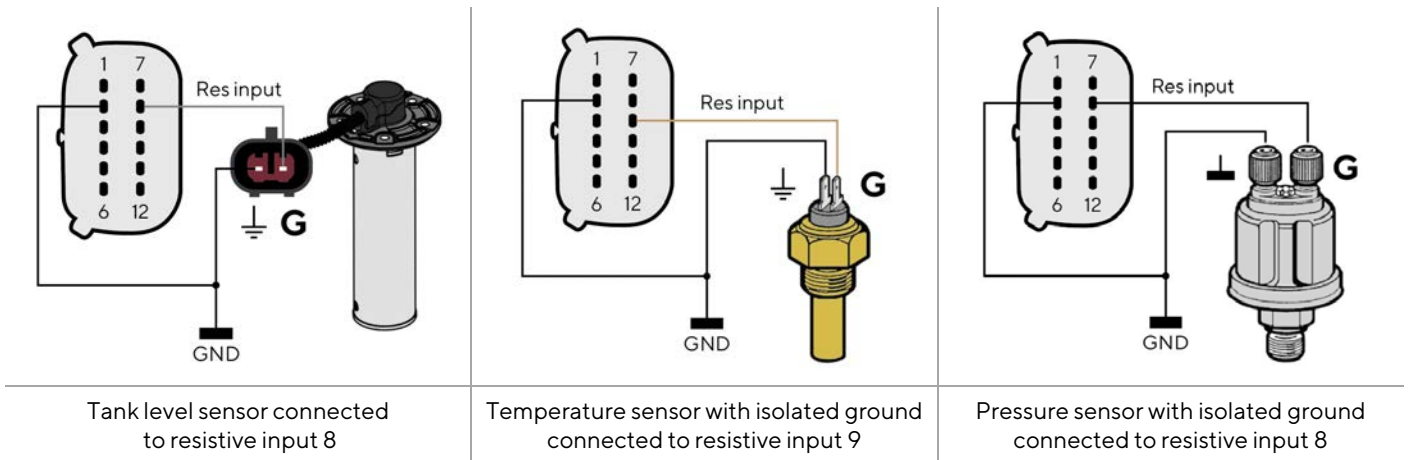

EXTERNAL BUZZER CONNECTION (B1)

The display supports the connection of two external alarms (B1/B2) via the dedicated alarm outputs.

This buzzer/lamp can be powered at different voltages (consult the buzzer manufacturer's manual), as the alarm output is connected to ground inside the display.

It is important to note that the maximum current supported is 500mA.

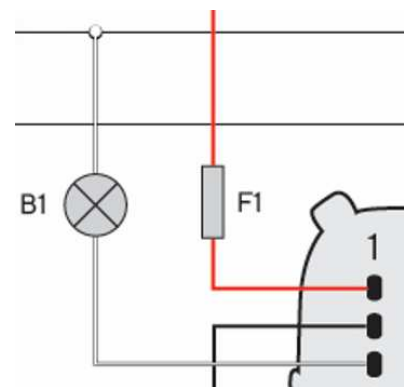

DAY / NIGHT MODE SELECTOR SWITCH (S1)

The display allows you to set two display illumination levels, one for day and night.

It is possible to switch between day and night mode by means of a switch external to the display (S1) connected to the power supply (KL.30), or by connecting to the lights signal onboard KL.58, if present.

Every 0-5V input of the display can be configured for this purpose (see "Sensors' configuration").

To set the desired mode, act on the selected illumination input pin on the MX150 connector as follows:

To set the mode...	Then...
day	move the pin switch to GND/OPEN .
night	move the pin switch to BATTERY PLUS .

In the sensor settings the function of the according voltage input must be defined as illumination input.

GETTING STARTED

OPERATION

OceanLink Display 7" TFT is a versatile device. It lets you control all connected engines in a single monitoring point and at the same time. The engine whose data is displayed is selected during data page configuration.

PRIORITY OF RECEIVED SIGNALS

If the same data is available from more than one source for the same engine, the received signal priority is the following:

- Analog input
- SAE J1939
- NMEA 2000





SWITCHING ON AND OFF

The on/off mode depends on the ignition signal on terminal 15 (Engine1 connector, pin 7).

At power up, logo and software version followed by a security message appear when turned on followed by the last data page viewed before turned off.

You can customize the loading image displayed at power up using the Veratron Configuration Tool. Contact your veratron dealer for more information.

BUTTON FUNCTIONS

Button	Name	Function
	MENU	Briefly press: <ul style="list-style-type: none"> • Open the menu • Return to the previous menu Hold down: <ul style="list-style-type: none"> • From any point to return to the data pages
	UP DOWN	Briefly press: <ul style="list-style-type: none"> • Scroll pages/options Pressed simultaneously: <ul style="list-style-type: none"> • Set the display and connected 52 mm gauges brightness
	ENTER	Briefly press: <ul style="list-style-type: none"> • Open a sub-menu • Confirm the selection Hold down: <ul style="list-style-type: none"> • In the MediaBox page to save the selected station radio frequency
	TOUCH BUTTON	Briefly press: <ul style="list-style-type: none"> • View the data page linked to the button Hold down: <ul style="list-style-type: none"> • Link the button to the displayed data page

CALIBRATION WIZARD

The Calibration wizard appears when first turned on after reset and every time turned on until sensors are calibrated.

The display prompts you to configure your sensors.

Choose Yes, to open menu SENSOR CONFIG.

Choose No, to display the first default data page and configure the sensors later.

STARTUP CHECKLIST

Following are the steps for initial configuration:

1. Connect any sensors to analog inputs.
2. When turned on, read the security message, then select Yes to open the menu SENSOR CONFIG and configure sensors (see "Sensor configuration").
3. Set up general device operations (see "System settings").
4. Add/remove data pages selecting the best layout and data to be viewed (see "Data page configuration").
5. If a page layout with bar graphs is used, customize the minimum and maximum intervals (Bar graph settings, see "System settings").
6. Enable/disable local, NMEA 2000 and J1939 alarms (see "Alarm management").

UPLOAD A CUSTOM SPLASH LOGO

A custom splash logo can be loaded from a PC using the veratron Configuration Tool. That logo will always be displayed during the startup process.

For more information, please refer to the veratron Configuration Tool user manual or contact your veratron reseller.

DATA SCREENS

Data screens show the data received from the various sources. The display can store up to 10 data screens. By default, four screens are displayed, configured to display the previously selected engine, and one page for remote management of a MediaBox multimedia device.

The ALARMS page appears at the end of the data pages if there are active alarms.

SCREENS SCROLLING

To scroll pages, press the UP or DOWN buttons or scroll the touch screen horizontally with your finger. To add/delete/edit pages, see "Data page configuration".

SCREEN LAYOUTS

Every screen contains some common elements, which are always displayed independently of the screen layout which is chosen.

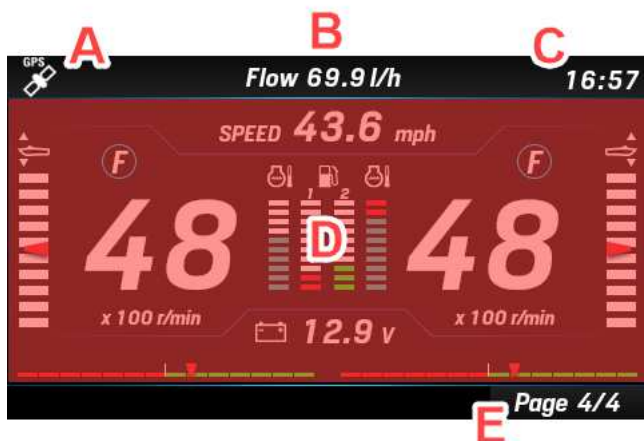

Part	Description
A	GPS signal availability (not included)
B	Screen title or additional data field (fixed)
C	GPS time (if received)
D	Screen content
E	Page number

The screen content [D] depends on the screen configuration that the user has selected for a specific screen (see "Screen Configuration").

Each screen can be customized with one of the following available layouts:

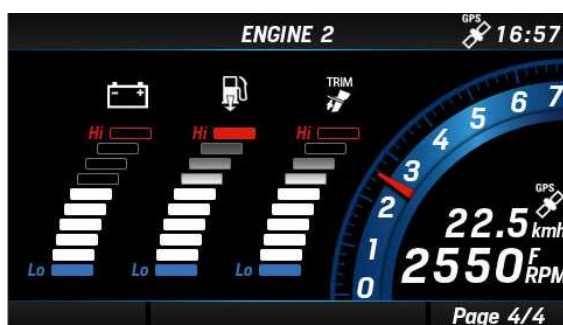

SINGLE ENGINE layout

with three bar graphs for the three data selected from Boost pressure, Trim, Engine coolant temperature, Battery voltage, Fuel consumption. One engine revolution gauge not editable.

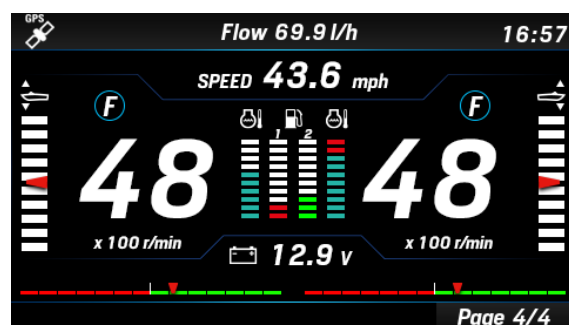

DUAL ENGINE layout

with three bar graphs for the three defined data: trim, engine coolant temperature, fuel level. Also the rudder angle, the engine speed, the battery voltage, the speed and the gear are displayed.

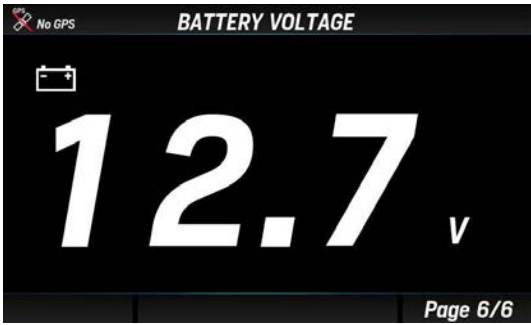

SINGLE DATA layout

Single data display. The data value is numeric or displayed by a gauge.



TRIPLE DATA layout

Three boxes, from three data to nine data.

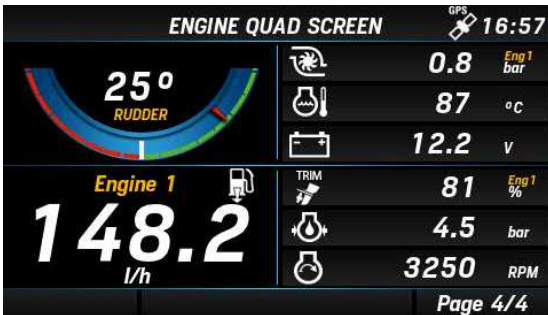

QUAD DATA layout

Four boxes, from four data to twelve data.

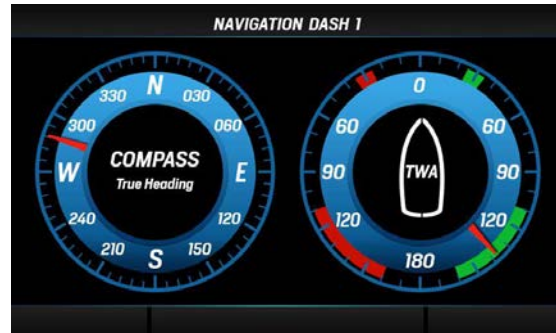

NAV DASH screens

This layout allows to display data in an analog fashion. Three NavDash layouts are available with two, three, or eight gauges into the screen.

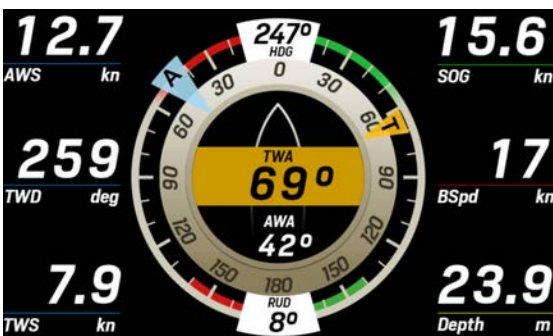

WIND screen

Dedicated screen layout for navigation with graphical representation of both apparent and true wind data. Six customizable data fields are designed aside.



RADIO screen

Screen used to operate the MediaBox multimedia unit (See "MediaBox use").

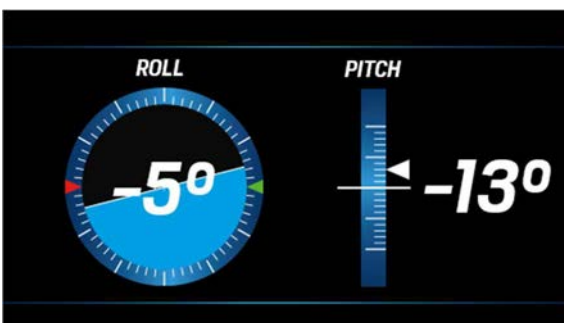

PITCH AND ROLL screen

Monitors your boat inclination, with the information retrieved from a connected NavSensor, for example.

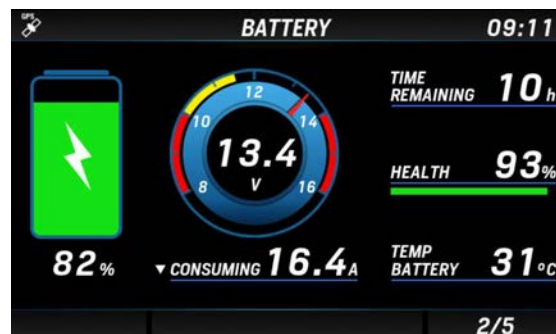

INTELLIGENT BATTERY MONITOR screen

Dedicated screen for battery monitoring including extensive battery information coming from the Intelligent Battery Sensor (IBS).

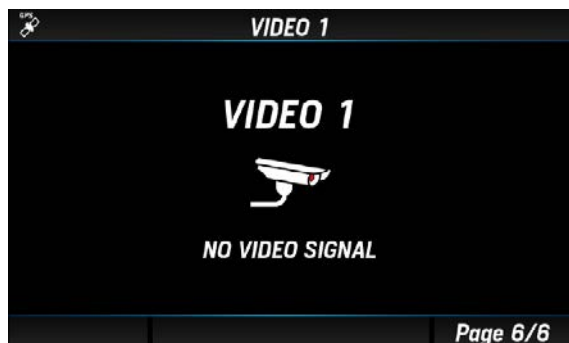













VIDEO screen

Displays the video received from the external video camera.

SUPPORTED DATA

Icon	Data	Input			Output		Unit
		NMEA 2000	SAE J1939	Analogue	NMEA 2000	EasyLink	
	Engine rpm	x	x	x	x	x	rpm
	Engine trim	x	-	x	x	x	%
	Engine boost pressure	x	x	x	x	x	bar , psi , kPa
	Engine coolant temp	x	x	x	x	x	°C , °F
	Battery voltage	x	-	x	x	x	V
	Fuel level (Tank: 1-4)	x	x	x	x	x	%
	Fuel rate	x	x	-	-	-	gal/h , L/h
	Fuel pressure	x	x	-	-	-	bar , psi , kPa
	Air Intake Temperature	-	x	-	-	-	°C , °F
LOAD	Engine load	x	x	-	-	-	%
	Exhaust temperature	x	x	-	-	x	°C , °F
	Engine oil temperature	x	x	x	x	x	°C , °F
	Engine oil pressure	x	x	x	x	x	bar , psi , kPa
	Transmission oil temperature	x	x	x	x	x	°C , °F
	Transmission oil pressure	x	x	x	x	x	bar , psi , kPa
	Engine hours	x	x	x	x	-	h
	Rudder angle	x	-	x	x	x	°
	Depth	x	-	-	-	-	m , ft

DATA SCREENS

Icon	Data	Input			Output		Unit
		NMEA 2000	SAE J1939	Analogue	NMEA 2000	EasyLink	
	Fresh water level (Tank: 1-4)	x	-	x	x	x	%
	Waste water level (Tank: 1-4)	x	-	-	x	x	%
	Sea water temperature	x	-	-	-	-	°C, °F
AIR TEMP	Air temperature	x	-	-	-	-	°C, °F
BARO	Atmospheric pressure	x	-	-	-	-	hPa
	Course over ground (COG)	x	-	-	-	-	°
	True heading	x	-	-	x	-	°
AWA	Apparent wind angle (AWA)	x	-	-	x	-	°
	Apparent wind speed (AWS)	x	-	-	x	-	km/h
TWA	True wind angle (TWA)	x	-	-	-	-	km/h
	True wind speed (TWS)	x	-	-	x	-	km/h
	True wind direction (TWD)	x	-	-	x	-	°
	Speed through water (STW)	x	-	-	-	-	mph, kn, km/h
	Trip distance	-	-	-	-	-	km, mi, nm
	Trip time	-	-	-	-	-	h
	Trip fuel	-	x	-	-	-	L, gal
	GPS speed	x	-	-	-	-	mph, kn, km/h
ROLL	Roll	x	-	-	-	-	°
PITCH	Pitch	x	-	-	-	-	°
-	Position	x	-	-	-	-	°
SOC	Battery Charge	x	-	-	-	-	%
-	Battery Current	x	-	-	-	-	A
-	Battery Autonomy	x	-	-	-	-	h, d
SOH	Battery Health	x	-	-	-	-	%
-	Battery Temperature	x	-	-	-	-	°C, °F

Note*: internally calculated data

ENGINE HOURS

In the absence of data received from the NMEA 2000 network, the indicator considers the internally counted value. The time is counted as engine hours when the engine speed is more than 300 RPM. In the presence of data from the NMEA 2000 network, the indicator considers the data received from the network only if higher than the internal data.

DISTANCE TRAVELED

The indicator internally calculates the distance travelled based on the speed while taking in account the correction factor set in Sensors > Speed.

NAVDASH LAYOUT

The NavDash layout is available in three different configurations with respectively two, three, and eight round gauges displayed.

Every layout is displayed in blue or amber color palette, and in day or night mode depending on the current display setup.

Each of these configurations can be customized with different gauges, selectable among the following:

- Engine revolutions
- Depth
- Rudder angle
- Apparent wind angle (AWA)
- Apparent wind speed (AWS)
- True heading
- Speed through water (STW)
- Speed over ground (SOG)
- Fuel level
- Fresh water level
- Waste water level
- Trim
- Battery voltage



SCREEN CONFIGURATION

1. Access the HOME screen by pressing the MENU button and select SCREEN CONFIG to enter the screens' configuration.



2. Scroll the favorite screens until the one to be customized (or deleted) is displayed and press ENTER to confirm.

To add a new screen at the end of the favorites, just scroll until an empty screen slot is selected.

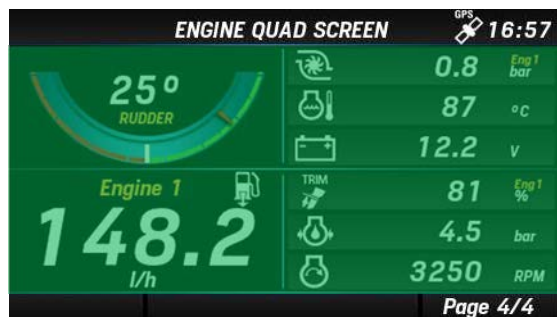

3. Choose the screen layout for the new screen among the ones described in "Screens layouts".

To delete the selected screen, select REMOVE PAGE.

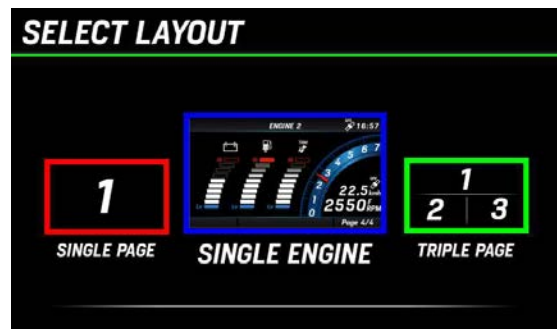

4. Depending on the chosen layout it is possible to customize some parts of the screen like data fields or bar graphs.

The currently selected item is highlighted in green color.

Scroll through the customizable items by pressing the UP and DOWN buttons.

Press ENTER to select the item to be customized.

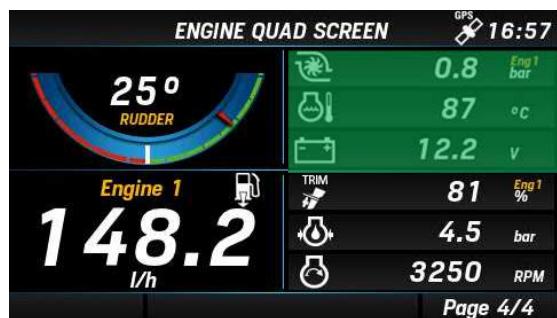

Press ▲ or ▼ to select the next field

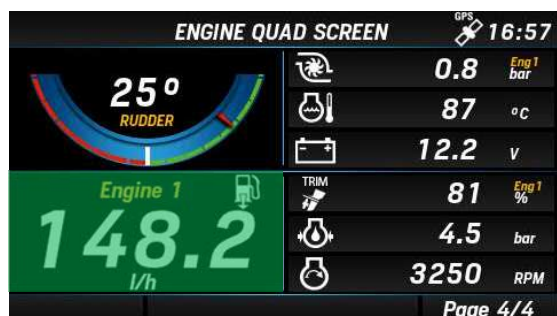

SCREEN CONFIGURATION

- Once an item is selected it will be highlighted in red color.

Press the UP/DOWN buttons to modify the data displayed on that item.

See "Supported Data" for the complete list of available data.

Once the displayed data is found, press ENTER to confirm the selection and the item is highlighted in green color again.

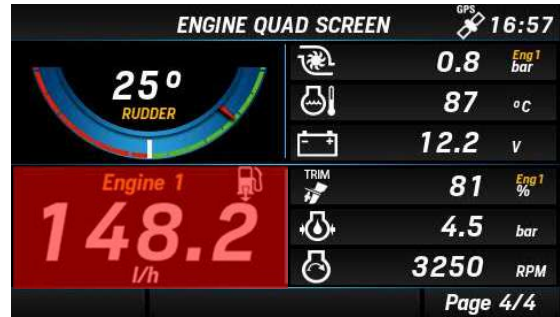

Press ▲ or ▼ to change the data

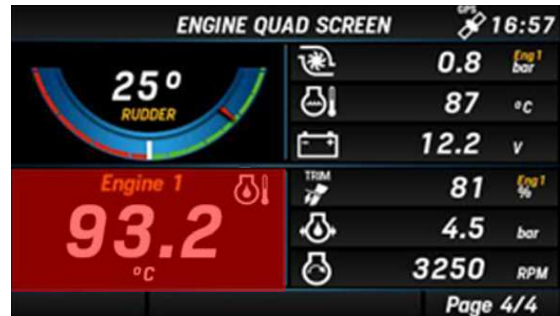

- To customize another screen, press BACK many times until you're back to the screen selection described at point 2.

To quite the settings and return to normal operation, long press the BACK button.

SYSTEM SETTINGS

To access the system settings, enter the HOME screen by pressing the MENU button and select SYSTEM CONFIG to enter the screens' configuration.



SYSTEM CONFIG STRUCTURE

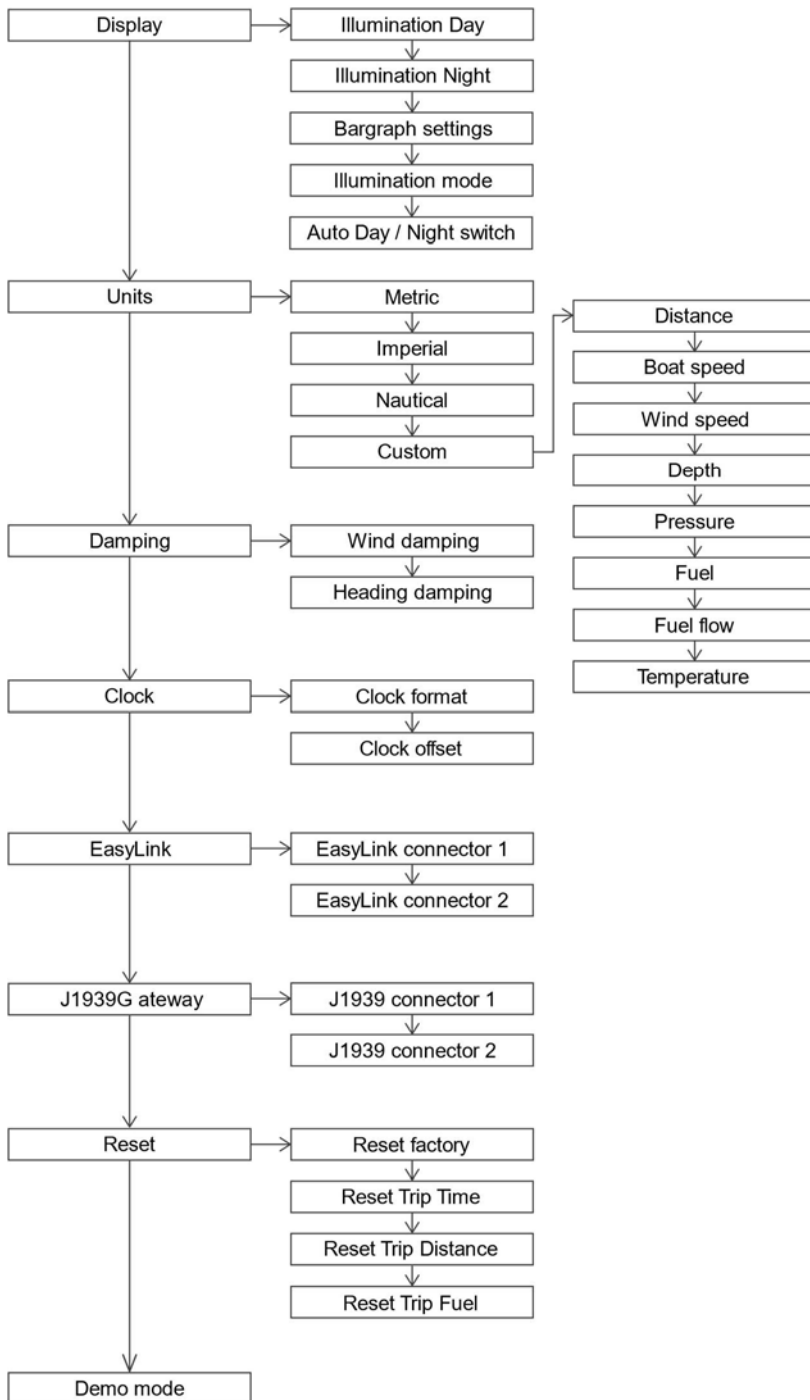

OPERATING THE SYSTEM CONFIG MENU

NOTE: the underlined value/command is the factory default one.

Setting	Description	Possible values / commands
Display > Illumination Day	Brightness of the display for the day mode. <i>NOTE: this setup affects all the EasyLink gauges too.</i>	<u>0-7</u> , Auto
Display > Illumination Night	Brightness of the display for the night mode. <i>NOTE: this setup affects all the EasyLink gauges too.</i>	<u>0-7</u>
Display > Bargraph settings	Bar graphs minimum and maximum setup.	<ul style="list-style-type: none"> • Boost press: 0-13 bar (default = 0-1) • Engine temp 0-300 °C (default = 0-200) • Battery voltage 8-32 V (default = 10-16) • Fuel flow 0-800 l/h (default = 0-150)
Display > Illumination mode	Color palette and brightness profile selection.	<ul style="list-style-type: none"> • Blue day: blue dials, white numbers, Illumination:7 • Blue night: blue dials, red numbers, Illumination:2 • Amber day: amber dials, white numbers, Illumination:7 • Amber night: amber dials, red numbers, Illumination:2
Display > Auto Day/Night Switch	Enable the built-in light sensor to automatically change between day and night mode and sets at which level of brightness the display should toggle. <i>NOTE: This is only possible if the Illumination input (term. 58) is disabled in the sensor configurations.</i>	<ul style="list-style-type: none"> • <u>OFF</u> • Bright • Medium • Dark
Units	Unit of measure for the displayed data.	<ul style="list-style-type: none"> • <u>Metric</u> • Imperial • Nautical • Custom
Damping > Wind damping/ Heading damping	Damping for wind and heading displayed data.	<ul style="list-style-type: none"> • No • <u>Low</u> • Medium • High
Clock > Clock format	Clock format.	<ul style="list-style-type: none"> • <u>12 h</u> • 24 h

SYSTEM SETTINGS

Setting	Description	Possible values / commands
Clock > Clock offset	Time zone setup.	From -12h to +12 h (<u>Q</u> h)
EasyLink > EasyLink connector 1 / EasyLink connector 2	Which engine and tanks are to be displayed on the EasyLink gauges. Only OceanLink satellites supported.	<ul style="list-style-type: none"> • Show engine data from: Engine 1-4 • Show fuel from: Tank 1-4 • Show fresh water from: Tank 1-4 • Show waste water from: Tank 1-4
J1939 > Connector1 / Connector 2	Configuration for the SAE J1939 to NMEA 2000 gateway. All the data received from the J1939 bus will be sent on NMEA 2000 with the instance specified here.	Send to NMEA 2000 As: <ul style="list-style-type: none"> • <u>Auto</u>: the display keeps the J1939 engine identifier also for the NMEA 2000 network. • Engine 1-4
Reset > Reset factory	Reset the display to factory default.	<ul style="list-style-type: none"> • Yes • <u>No</u>
Reset > Reset Trip time		<ul style="list-style-type: none"> • Yes • <u>No</u>
Reset > Reset Trip Distance		<ul style="list-style-type: none"> • Yes • <u>No</u>
Reset > Reset Trip Fuel		<ul style="list-style-type: none"> • Yes • <u>No</u>
Reset > Reset MediaBox	Only available with a MediaBox device connected. The MediaBox settings are reset to factory default.	<ul style="list-style-type: none"> • Yes • <u>No</u>
Demo mode	Demo mode activation. Simulated data are NOT sent on NMEA 2000. <i>Note: the demo mode will remain active after the unit is restarted.</i>	<ul style="list-style-type: none"> • <u>On</u>: display data are simulated. The simulation is sent on EasyLink satellites too. • <u>Off</u>: demo mode is off.

UNITS

Setting	Metric	Imperial	Nautical	Custom
Distance	km	mi	nm	km, mi, nm
Boat speed	km/h	mph	kn	km/h, mph, kn
Wind speed	km/h	kn	kn	km/h, kn, m/s, bft
Depth	m	ft	ft	m, ft
Pressure	bar	psi	psi	bar, psi, kPa
Fuel	L	gal	gal	L, gal
Fuel flow	L/h	gph	gph	L/h, gph
Temperature	°C	°F	°F	°C, °F

CHANGE THE BRIGHTNESS OF THE DISPLAY

There's a shortcut to change the brightness of the display. The change affects the set day or night mode.

- Press and hold the buttons UP and DOWN until the menu Illumination appears.
- Change the illumination brightness with the buttons UP and DOWN.
- Confirm and close the menu with ENTER
- To exit the menu without saving the changes press the MENU

SAE J1939 GATEWAY

The OceanLink display is equipped with two independent SAE J1939 ports to connect your CAN engines to the display and read the digital data coming from them.

Make sure to properly setup the J1939 gateway so that all the engine data are transmitted on NMEA 2000 with the correct instance.

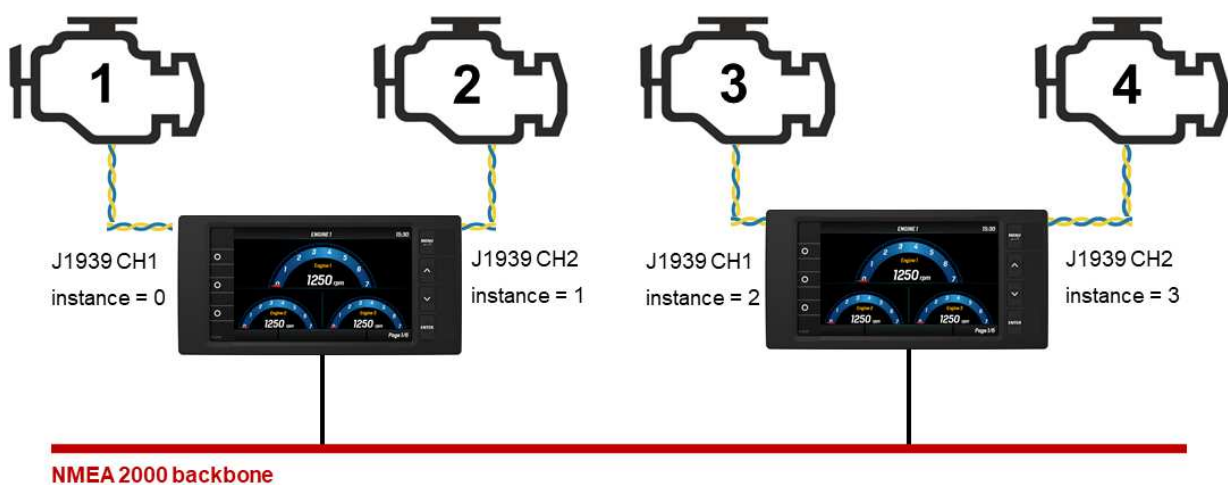

SENSORS' CONFIGURATIONS

To access the sensors' settings, enter the HOME screen by pressing the MENU button and select SENSOR CONFIG to access it.



SYSTEM CONFIG STRUCTURE

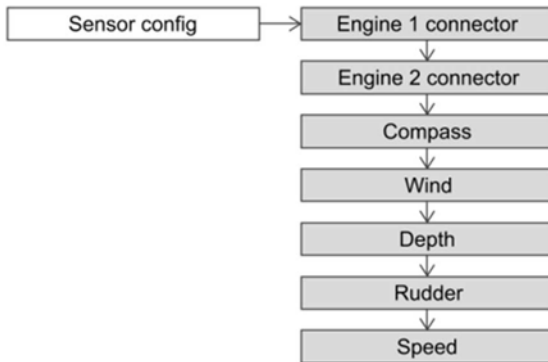

Setting	Description	Possible values
Engine 1 connector	Configure the sensors connected to the display through the analogue inputs of the Engine 1 connector (see "Connections").	-
Engine 2 connector	Configure the sensors connected to the display through the analogue inputs of the Engine 2 connector (see "Connections").	-
Compass > Heading offset	Angular offset between True North and the bow of the boat.	$\pm 0 - 180^\circ (0^\circ)$
Compass > Variation	Magnetic variation offset (polar difference between Magnetic North and True North)	$\pm 0 - 180^\circ (0^\circ)$
Compass > Send True Heading	Activate to let the display transmit the calculated True Heading over NMEA 2000.	Yes / No (No)
Wind > Wind direction offset	Angular offset between the wind sensor 0° position and the longitudinal boat axis.	$\pm 0 - 180^\circ (0^\circ)$
Wind > Send True Wind	Activate to let the display transmit the internally calculated True Wind data (TWA and TWS) over NMEA 2000.	Yes / No (No)
Depth	Depth offset setup. Positive for depth below waterline, negative for depth below keel.	$\pm 0 - 9.9\text{m} (2\text{m})$
Rudder	Rudder offset setup.	$\pm 0 - 120^\circ (0^\circ)$
Speed > Speed correction factor	Correction for the boat speed data received via NMEA 2000. See "Calculate the speed offset".	$0 - 199.99 (1.00)$

CONFIGURE A SENSOR CONNECTED TO THE DISPLAY

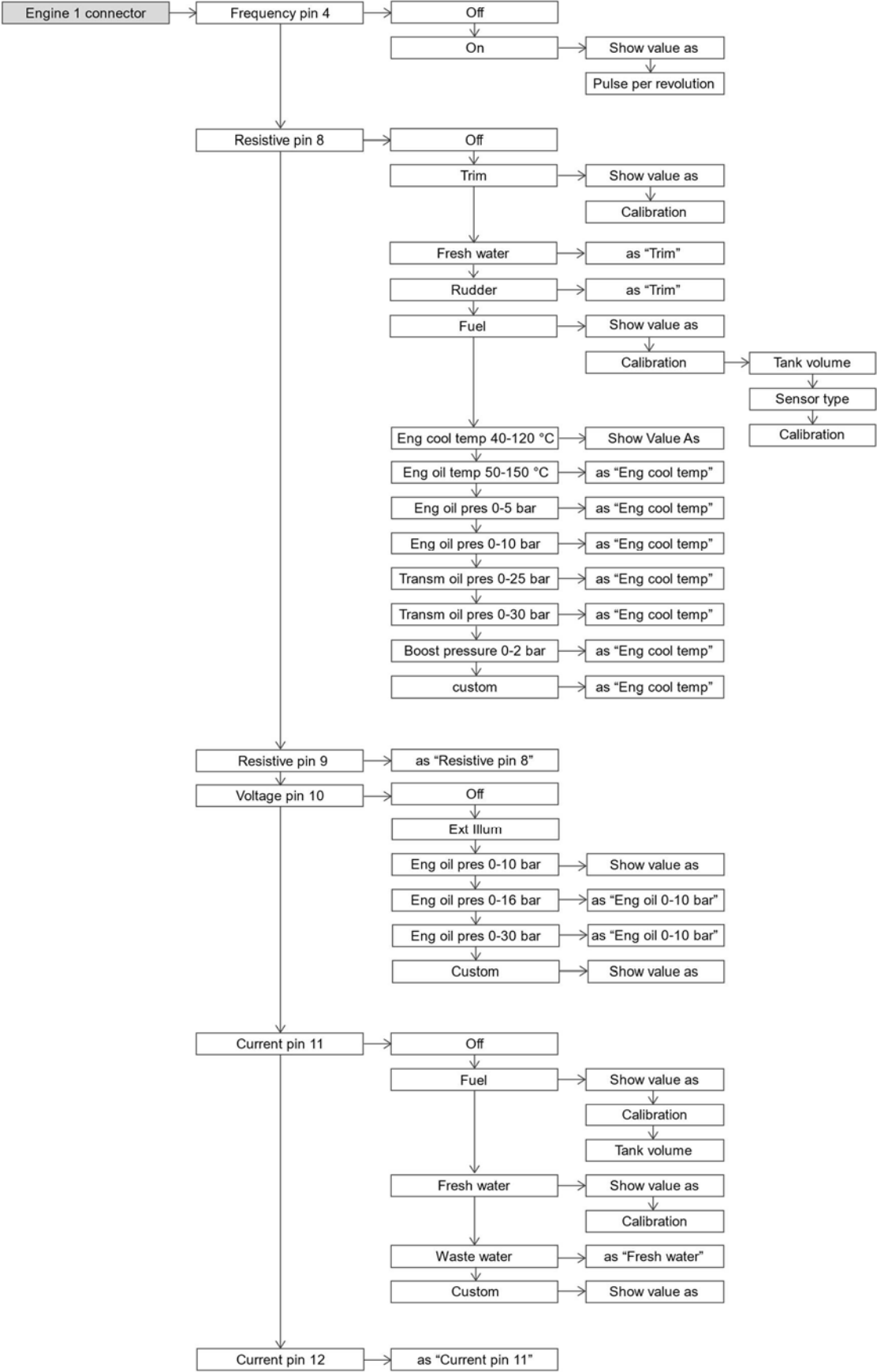

1. INPUT SELECTION

Once in the SENSOR CONFIG menu, select “Engine 1 connector” or “Engine 2 connector” depending on which connector the sensor is electrically connected to.

Then select the analogue input (on that connector) where the sensor output is wired.

2. CHOOSE THE SENSOR TYPE

Select what kind of sensor is connected to that input.

See the menu diagram for the complete list of supported sensors.

Select “Custom” for importing the complete input configuration from the PC Veratron Configuration Tool.

3. CONFIGURE THE NMEA 2000 OUTPUT

The measured value for the configured analog sensor is also transmitted over NMEA 2000, so the OceanLink display will act as a source for that data.

Use the menu item “Show Value As” to modify the NMEA 2000 instance for that sensor.

If a configuration conflict is detected in the setup (like when two sensors with same instance are configured on different analog ports), the display will show a warning.

4. CALIBRATE THE SENSOR

Every sensor type has a standard calibration (see “Default supported calibrations”). Veratron sensors are by default supported.

It is however possible, for some sensors, to calibrate the sensor through a calibration wizard (see next chapters).

Every sensor type can be always calibrated via the PC-based veratron Configuration Tool (see “Sensor calibration with Veratron Configuration Tool”).

SENSORS' CONFIGURATION

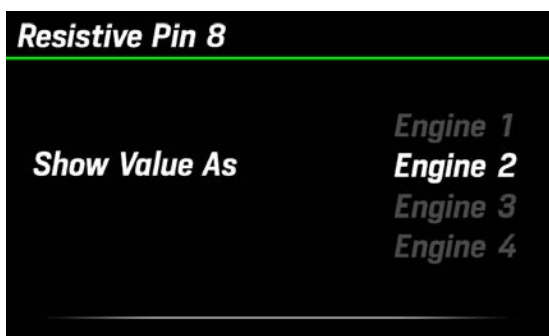
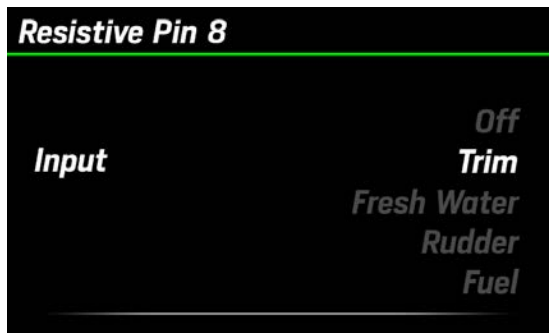
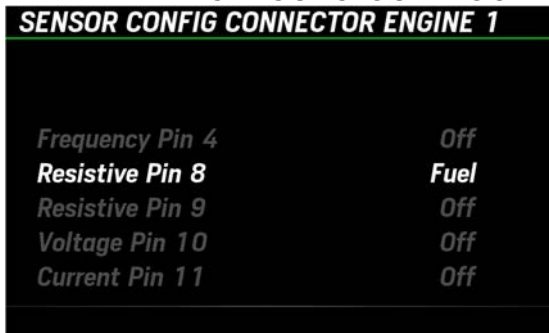

FUEL LEVEL SENSOR CALIBRATION

1. In the input configuration menu described before, select "Calibration" to open the sensor's calibration options.
2. Select **Tank volume** to set the tank's capacity (not mandatory).
3. Select **Sensor type**, then select the sensor type among the proposed standard ones.
4. Select **Calibration**, then select the one or three-point calibration procedure (**Do 1 point cal/Do 3-point cal**). Calibration instructions and the ohmic value read in real-time from the sensor [A] appear.
5. Empty the tank and wait for the read value to stabilize. Then confirm by pressing ENTER.
6. For three-point calibration, follow the on-screen instructions.
7. Hold down the MENU button to return to the data pages.

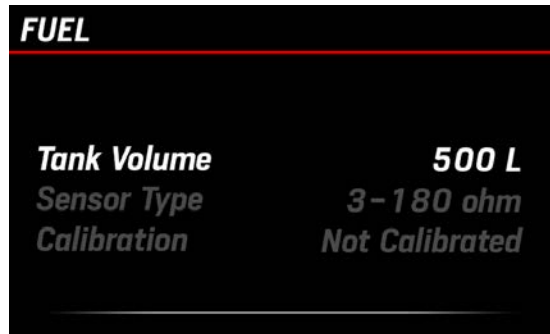

OTHER SENSORS' CALIBRATION

1. In the input configuration menu described before, select **Calibration** to open the sensor's calibration options.
2. Then select the three-point calibration procedure by accessing **Do 3-point cal**. Calibration instructions and the ohmic value read in real-time from the sensor appear.
3. For fresh and waste water sensors the tanks must be drained, then wait for the read value to stabilize. Confirm the reading by pressing ENTER.
4. Proceed with all calibration points following the wizard.
5. Hold down the MENU button to return to the data pages.

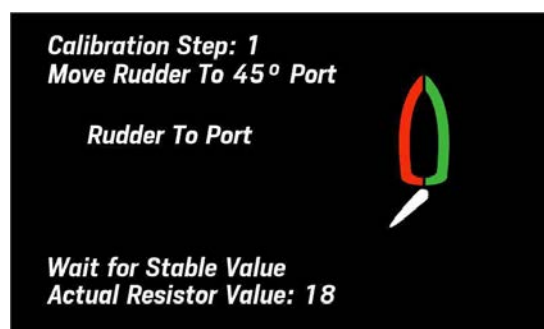
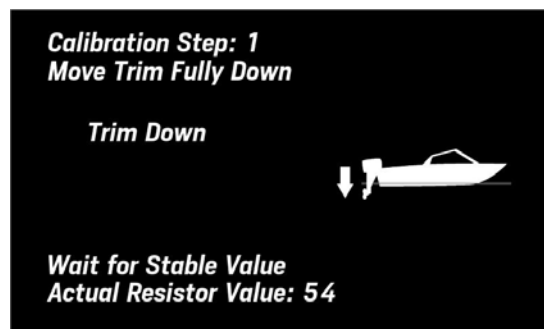

CUSTOM SENSORS CONFIGURATION

In the bottom part of the Sensor Configuration panel, it is possible to fully customize the configuration of every analog port of your OceanLink display.

NOTE: this operation still requires you to perform some setting on the display itself (set the input to "Custom" and select the data instance).

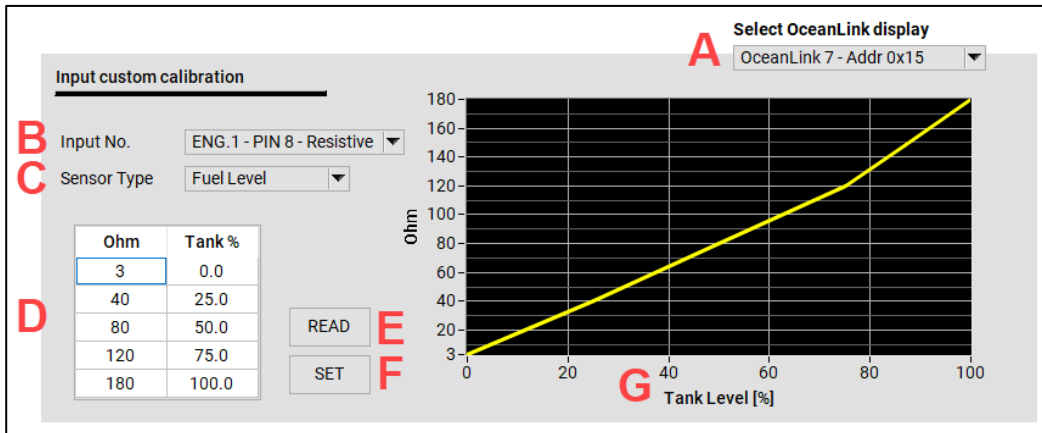

- 1** Select the display to be programmed from the drop-down list [A].
If more OceanLink displays are on the network, they will all be visible in this list.

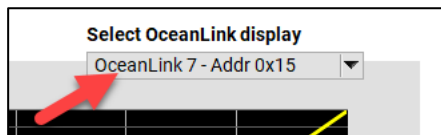

- 2** **IN THE DISPLAY MENU** set the pin configuration to "CUSTOM".
Sensor Config → Choose the port to be configured → Input → Custom

This setup is required on the display to allow the local pin configuration to be overwritten.

When CUSTOM is selected, the configuration must come from the Tool.

- 3** Back on the PC Tool, **select the input to configure [B]**.
This selection must match the pin configured as CUSTOM on the display in the step before.

- 4** **Select the Sensor type** from the drop-down list [C].

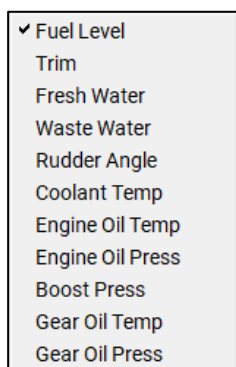

- 5 Manually set the 5-points calibration** into the table [D] for the selected sensor.
The graph [G] will display the calibration being set.

Ohm	Tank %
3	0.0
45	25.0
90	50.0
135	75.0
180	100.0

The example above is for a standard 3-180Ω fuel level sensor.

- 6 Upload the configuration** to the display.
Press the SET button [F] to write the configuration for the specific pin.
A popup will appear as a safety confirmation.
- Press the READ button [E] to read back from the display the configuration for the pin defined in [A].

DEFAULT CALIBRATIONS

Sensor Type	Calibration
Fuel	240-33 Ω
	3-180 Ω
	2-90 Ω
Fresh Water	3-180 Ω (resistive inputs)
	4-20mA (capacitive inputs)
Waste Water	3-180 Ω (resistive inputs)
	4-20mA (capacitive inputs)
Trim	10-167 Ω
Rudder	10-180 Ω
Eng Coolant Temp	291-22 Ω
Eng Oil Temp	197-11 Ω
Eng Oil Pressure	10-184 Ω
Boost Press	10-184 Ω

ADJUSTING THE SPEED CORRECTION FACTOR

The speed correction factor lets you align the speed through water (STW) to the actual speed. If the measured speed differs from the real boat speed for more than 0.5 kn, this factor can be adjusted. Increasing the offset factor reduces the displayed speed through water (STW).

ALARMS

The OceanLink display can show active alarms coming from either NMEA 2000, SAE J1939, or from the analogue sensors directly connected to it. Engine alarms concern all engines on the network.



ALARMS MENU STRUCTURE

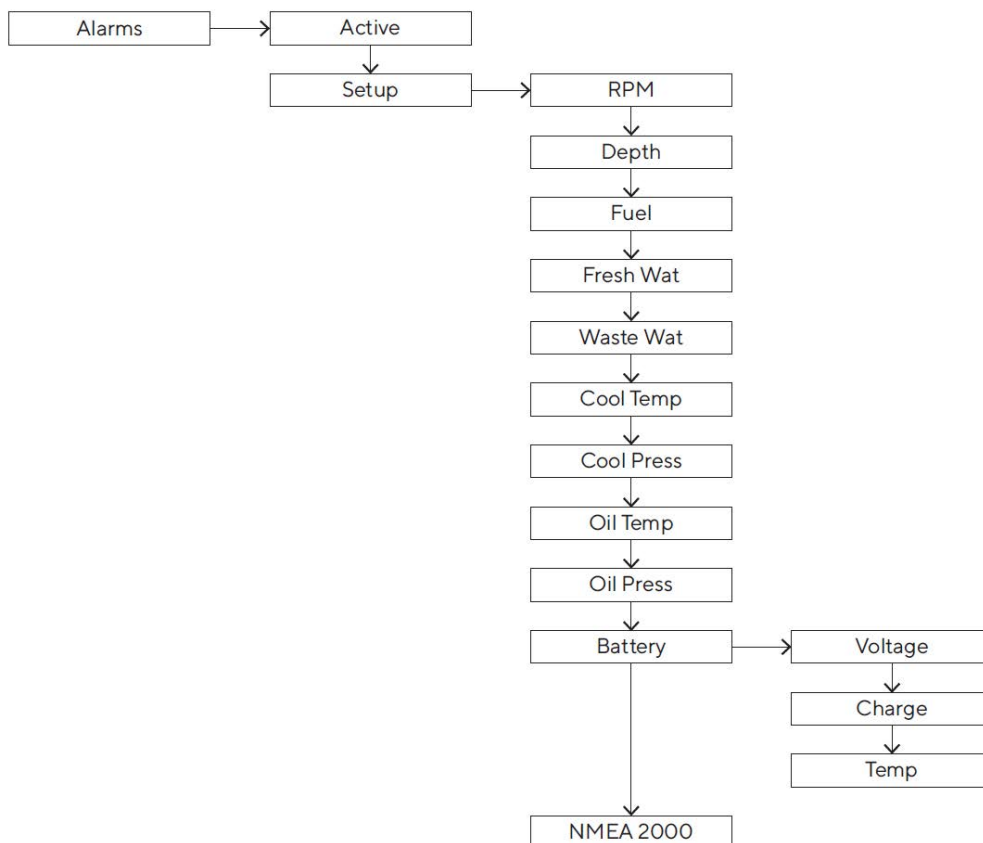

ALARMS NOTIFICATION

In the event of an alarm, the following appears on the display:

- The alarm popup appears
- The buzzer gets activated, if connected and set
- The active alarm, including additional information, is visible in the Active alarms screen
- If supported, the local alarm is transmitted to the NMEA 2000 network



ACKNOWLEDGE AN ALARM

When an alarm is triggered, the Alarm notification popup appears and the buzzer sounds (if connected and configured).

To acknowledge the alarm and mute the buzzer, press any button on the keyboard: the popup notification is closed, and the alarm is saved in the Active alarms screen.





The alarm remains displayed in the Active alarms screen as long as it remains active, and a warning icon is displayed in the bottom side of every screen to remind you that an alarm is currently active.

ACTIVE ALARMS

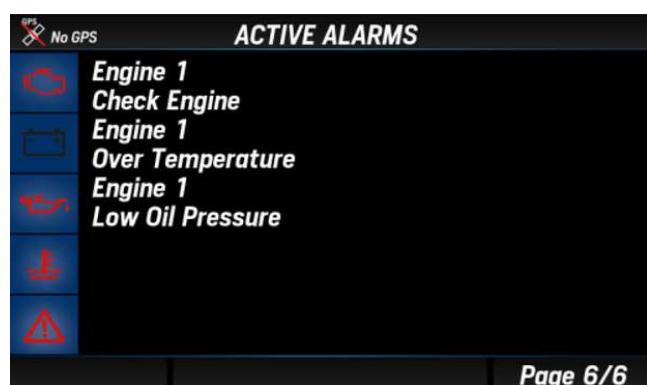
If at least one alarm is active, an "Active alarm" screen will appear after the last screen. The same screen can be accessed via ALARMS > Active alarms.

All the currently active alarms are listed here, together with some warning symbols.



Symbol	Description
	Engine alarms
	Battery alarms
	Oil alarms
	Engine temp alarm
	Generic alarm

CONFIGURE A LOCAL ALARM

1. Press the MENU button and select ALARMS > Setup
2. Select one of the supported alarms
3. Activate it by selecting Active > Yes, the alarm parameters will appear
4. Then select and edit the threshold(s) and enable/disable the buzzer

Setting	Description	Possible values	NMEA 2000 output
Depth shallow	Shallow water alarm.	0 – 9.9 m (2m)	No
Depth navigation	Depth navigation alarms. Deep water alarm (e.g., a value near the maximum value measurable by the sensor) and safety depth minimum threshold.	0 – 99.9 m (50m, 5m)	No
Wind	High wind speed.	0 – 99.9 km/h (39.9km/h)	No
Battery voltage	Low battery voltage.	0 – 32.9 V (10.8V)	Yes
Battery Temperature	High battery temperature.	0 – 99 °C (50°C)	No
Battery Charge	Low battery state of charge.	0 – 99 % (50%)	No
Engine water temp	High engine coolant temperature.	0 – 139 °C (110°C)	Yes
Engine oil temp	High engine oil temperature.	0 – 149 °C (120°C)	Yes
Engine oil pressure	Low engine oil pressure.	0 – 9.9 bar (0.5bar)	Yes
Exhaust Gas Temp	High EGT.	0 – 899 °C (500°C)	Yes
Fuel	Low fuel level.	0 – 99 % (20%)	No
Fresh water	Low fresh water level.	0 – 99 % (20%)	No
Waste water	High waste water level.	0 – 99 % (80%)	No
Local alarm input	External digital switch (low active alarm). Refer to “Connections’ diagram”.		No
Min RPM	RPM minimum threshold to trigger engine-related alarms.	0 – 990 RPM (300RPM)	-

CONFIGURE A CAN ALARM

1. Press the MENU button and select ALARMS > Setup
2. Select CAN and then the NMEA 2000 or SAE J1939 input
3. Choose the alarm to activate and select Active > Yes, the alarm parameters will appear
4. If necessary, enable/disable the buzzer

NMEA 2000 alarms Engine (PGN 127489)	NMEA 2000 alarms Transmission (PGN 127493)	SAE J1939 alarms (DM1)
Check engine Over temperature Low oil pressure Low oil level Low fuel pressure Low system voltage Low coolant level Water flow Water in fuel Charge indicator Preheat indicator High boost pressure Rev limit exceeded EGR system Throttle position sensor Engine emergency stop Warning level 1 Warning level 2 Power reduction Maintenance needed Eng com error Sub or secondary throttle Neutral start protect Engine shutting down	Transm. Check transmission Transm. Over temp Transm. Low oil pressure Transm. Low oil level Transm. Sail drive	Engine speed Boost pressure Exhaust gas temperature Engine oil pressure Engine coolant pressure Engine coolant temp Engine oil temp Transmission oil press Transmission oil temp Fuel Level Water in fuel

TROUBLESHOOTING

Problem	Root cause	Solution
The values displayed are not as expected.	Incorrect sensor configuration.	Check the configuration in the Sensors menu.
	Sensor connected incorrectly.	Check the connection, refer to the Installation Instructions.
	The NMEA 2000 network backbone has not been created correctly.	Check the connections and that there is a termination at both the beginning and end of the backbone.
“---” is displayed for a certain data or the pointer blinks in the NavDash layout.	The data is not available on the network.	Check that the sensor is functioning correctly.
	Sensor not connected.	Connect the sensor, refer to the Installation Instructions.
	The NMEA 2000 network backbone has not been created correctly.	Check the connections and that there is a termination at both the beginning and end of the backbone.
The same data is displayed with two different alternating values.	Incorrect sensor configuration. Two different sources are sending the same data on NMEA 2000.	Check the engine/tank IDs (Show value as) in the sensor configuration.
“No MediaBox connected”	MediaBox is not connected to the NMEA 2000 network or to the power supply.	Check the connection of the MediaBox unit.
“MediaBox not powered”	MediaBox is connected but off.	Turn on the MediaBox, see “MediaBox use”.

TECHNICAL DATA

GENERAL FEATURE

Material	Aluminum case PBT and mineral glass front screen
Display	IPS TFT 7" - 800x480 - Transmissive touch screen Full 24 bit / 16 mio. colors
Connectors	<ul style="list-style-type: none"> • 2x Molex MX150 12 pin • 1x NMEA 2000 Micro-C M12 5 pin • 2x AMP SuperSeal 1.5 Series (EasyLink) • 1x M12 4 pins "D" coding (Video)
Input data	<ul style="list-style-type: none"> • CAN (NMEA 2000 and SAE J1939) • 6x resistive inputs (0-400 Ω) • 2x capacitive inputs (4-20mA) • 2x frequency inputs (0-4 kHz) • 3x voltage inputs (0-5V) • 1x digital alarm input
Output data	<ul style="list-style-type: none"> • NMEA 2000 • 2x EasyLink • 2x Alarm outputs (500mA max)
Degree of protection (according to IEC 60529)	IPX7

ENVIRONMENTAL FEATURES

Operating temperature	From -25 to +70 °C
Storage temperature	From -40 to +85 °C

ELECTRICAL FEATURES

Rated voltage	12/24 V
Operating voltage	9-32 V
Current consumption	< 900 mA @ 12 V (display only) 100mA for each EasyLink satellite gauge
Absorption (LEN)	2

COMPLIANCE

Compliance	CE, UKCA, Reach, RoHS, UL94
Directives	2014/30/EU (Electromagnetic compatibility) 2011/65/EU (Hazardous substances in electrical and electronic equipment)
Reference standards	IEC 60945:2002-08 (environmental class: exposed)

SUPPORTED NMEA 2000 MESSAGES

Description	PGN	Description	PGN
J1939 Generator Average Basic AC Quantities	65030	Water depth	128267
J1939 Diagnostic Message #1	65226	Position: Rapid update	129025
J1939 Diagnostic Message #2	65227	COG and SOG: Rapid update	129026
J1939 Diagnostic Message #3	65228	GNSS position data	129029
J1939 Diagnostic Message #4	65229	Local Time Offset	129033
J1939 Diagnostic Message #5	65230	Datum	129044
J1939 Diagnostic Message #6	65231	Cross track error	129283
J1939 Diagnostic Message #8	65232	Navigation data	129284
J1939 Diagnostic Message #10	65234	Navigation route and waypoint info	129285
J1939 Diagnostic Message #11	65235	GNSS dilution of precision (DOP)	129539
J1939 Diagnostic Message #12	65236	GNSS satellites in view	129540
System time	126992	Wind data	130306
Rudder	127245	Environmental parameters	130310
Vessel heading	127250	Environmental parameters	130311
Rate of Turn	127251	Temperature	130312
Attitude	127257	Humidity	130313
Temperature (Old Version)	127258	Actual Pressure	130314
Engine Parameters, Rapid Update	127488	Entertainment - Current File and Status	130569
Engine Parameters, Dynamic	127489	Entertainment - Data File	130570
Transmission Parameters, Dynamic	127493	Entertainment - Data Group	130571
Engine Parameters, Static	127498	Entertainment - Data Search	130572
Fluid level	127505	Entertainment - Supported Source Data	130573
DC Detailed Status	127506	Entertainment - Supported Zone Data	130574
Battery status	127508	Small Craft Status	130576
Speed: Water referenced	128259		

DISPOSAL RESPONSIBILITY



Dispose of by separate collection through government or local government designated collection facilities.
Proper disposal and recycling will help prevent potentially negative consequences for the environment and people.

SPARE PARTS AND ACCESSORIES

SPARE PARTS

Product	Part Number
Power and data cable - Engine 1	A2C1507870001
Data cable - Engine 2	A2C1992110001
EasyLink extension cable	A2C59500139
Video input cable 0.3m	A2C1845710001
Plastic frame - black	A2C1697530001
Plastic frame - white	A2C1697540001
Sun cover	A2C59501973

ACCESSORIES

Product	Part Number
NMEA 2000 Power Cable	A2C3931290001
NMEA 2000 T-splitter	A2C3931270002
NMEA 2000 drop cable - 0.5m	A2C9624370001
NMEA 2000 drop cable - 2m	A2C9624380001
NMEA 2000 drop cable - 6m	A2C9624400001
NMEA 2000 terminator - Male	A2C3931100001
NMEA 2000 terminator - Female	A2C3931060001

For all available accessories, visit www.veratron.com.