



---

## **Istruzioni per l'uso**

*Instructions for use*

*Instructions d'utilisation*

*Gebrauchsanweisung*

*Instrucciones de uso*



**CONTAMETRI**

*CHAIN COUNTER*

*COMPTEUR MÉTRIQUE*

*METERZÄHLER*

*CUENTAMETROS*

**EV-020**

---

Rev. 11 – 2014

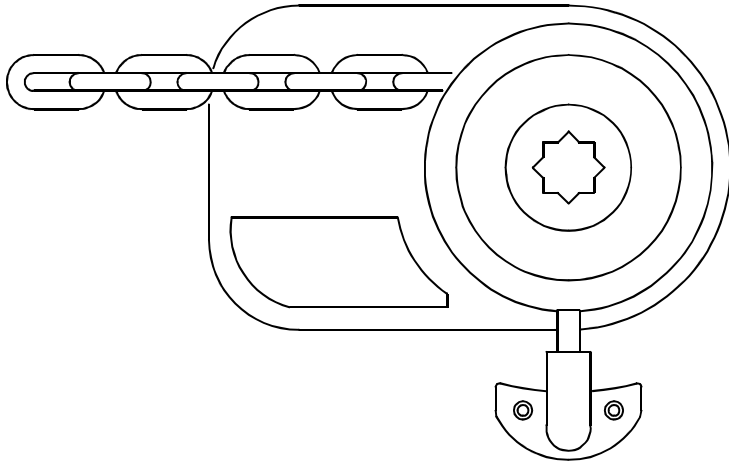

Fig. 1A

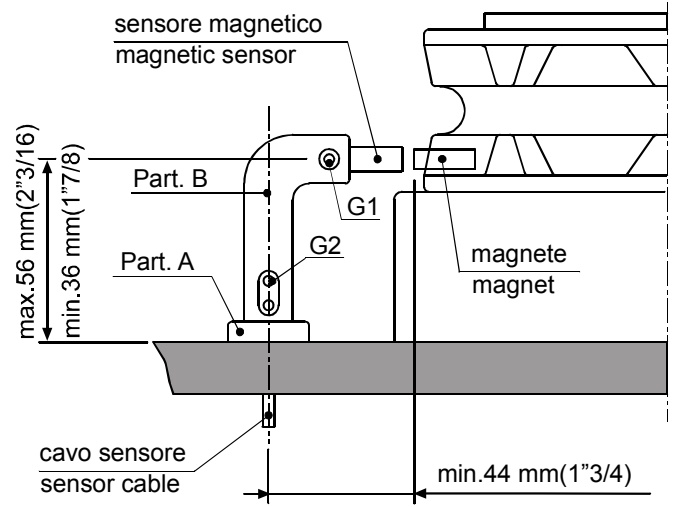

Fig. 1B

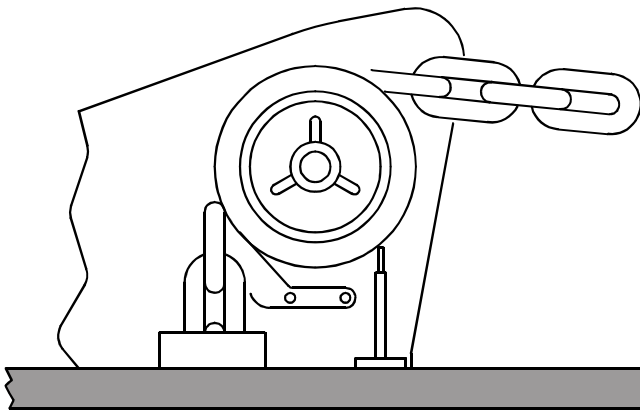

Fig. 2A

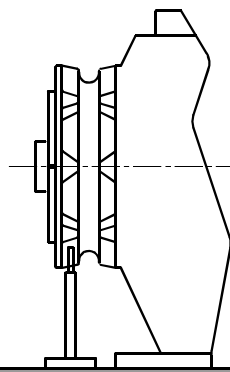

Fig. 2B

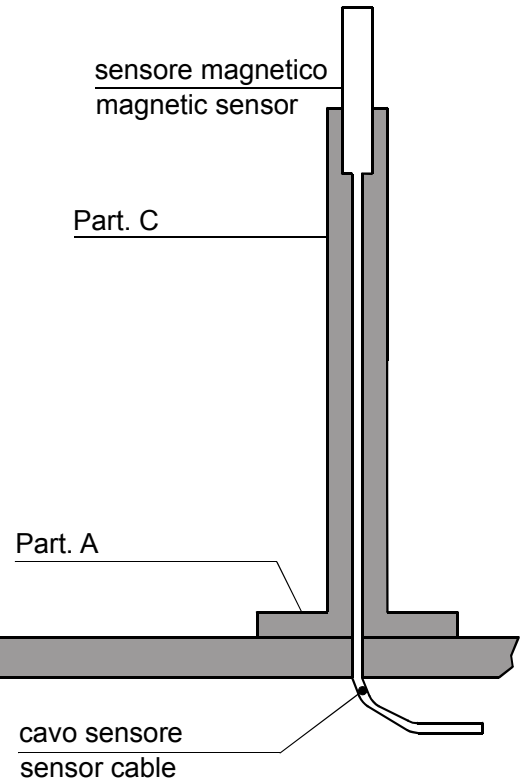

Fig. 2C

## Description

The **EV-020** chain counter displays the length of chain let out or down, expressed in metres or feet and the speed of the same.

## Technical data

Power supply	from 10 to 30 V DC
Current intake	min. 5 mA – max 50 mA
Protection rating	IP65
Operative temperature	0 / +70 °C (32 / 158 °F)
Graphic display	128 x 64 pixels
Max. chain length	999 metres – 999 feet
Size (mm)	145 x 50 x 24
Weight (g)	450*

\* with cable



**Warning**

**CONNECT ONLY TO A DC POWER SUPPLY.**

## General notes

The **EV-020** chain counter must be used solely for the purposes described herein, i.e. to operate and display the number of metres/feet of chain let out by an anchor windlass. Any other use is to be considered improper.

**Any tampering with the instrument will result in immediate voiding of the warranty.**

## Components

**The package contains:**

- chain counter with extensible cable and fastening kit (1 bracket with 2 screws);
- 6-pole connector tap with gasket, 4 fastening screws with spacer rings and plug;
- instructions for use.

## Installation

**On a few models of anchor windlass the sensor and the magnet are already installed (chain counter setting). Therefore, the operations described below are not necessary.**

### Installing the magnet on the anchor windlass

- A hole having a diameter of 6.5 mm (~1/4") and depth of 8 mm (5/16") must be drilled on a tooth of the gipsy, in a place outside the chain's path.
- In the case of vertical shaft anchor windlasses (see Fig. 1B), drill the hole in the lower circumference of the gipsy.
- In the case of horizontal shaft anchor windlasses (see Fig. 2B), drill the hole in the outer circumference of the gipsy.
- Also make sure that the protruding part of the magnet will not collide with the base or sensor during rotation of the gipsy.
- Insert the metal part of the magnet in the hole, allowing the protected part to protrude by about 2 mm. Fix it in place using an adhesive for metals (two-component epoxy glue) or silicone. The glue used must be able to withstand a marine environment.

### Installing the magnetic sensor for vertical shaft anchor windlasses

(see Fig. 1A – 1B)

- Drill a 4 mm (~3/16") hole in the cover through which to thread the sensor cable.
- Fasten Part A of the support with the two screws provided, after having positioned the O-ring in the lower part of the support.
- Fit Part B with the magnetic sensor on support A and adjust its height until it is aligned with the magnet fastened on the gipsy.
- Bring the sensor to a distance of about 3 mm (~1/8") from the magnet and secure it in place by tightening screw G1. Then tighten screw G2.

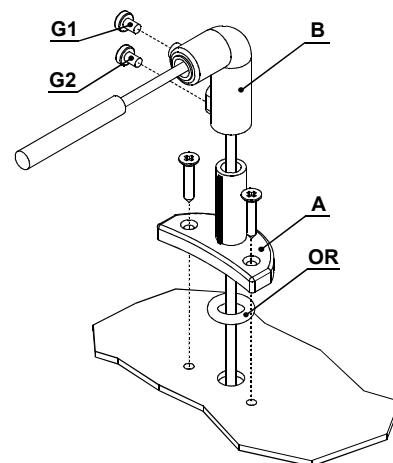

### Installing the magnetic sensor for horizontal shaft anchor windlasses

(see Fig. 2A – 2B – 2C)

- Drill a 4 mm (~3/16") hole in the cover through which to thread the sensor cable.
- Fasten Part A of the support with the two screws provided, after having positioned the O-ring in the lower part of the support.
- Cut Part C to measure using a hacksaw. The sensor must be positioned at a distance of about 3 mm (~1/8") from the magnet.
- Fit Part C with the magnetic sensor on support A and fix it in place using an adhesive for plastic (two-component epoxy glue) or silicone.
- Using the same glue, attach the sensor to Part C.

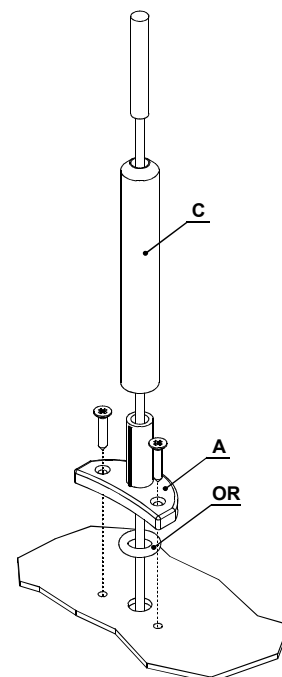

### Installing the chain counter

(see connection diagram)



**Warning**

**ALWAYS DISCONNECT THE BATTERY PRIOR TO INSTALLATION.**

- The chain counter must be positioned so that the display will be easy to read. It should not be exposed to direct sunlight.
- Secure the instrument in place with the bracket provided, tightening the two screws using a cross screwdriver.

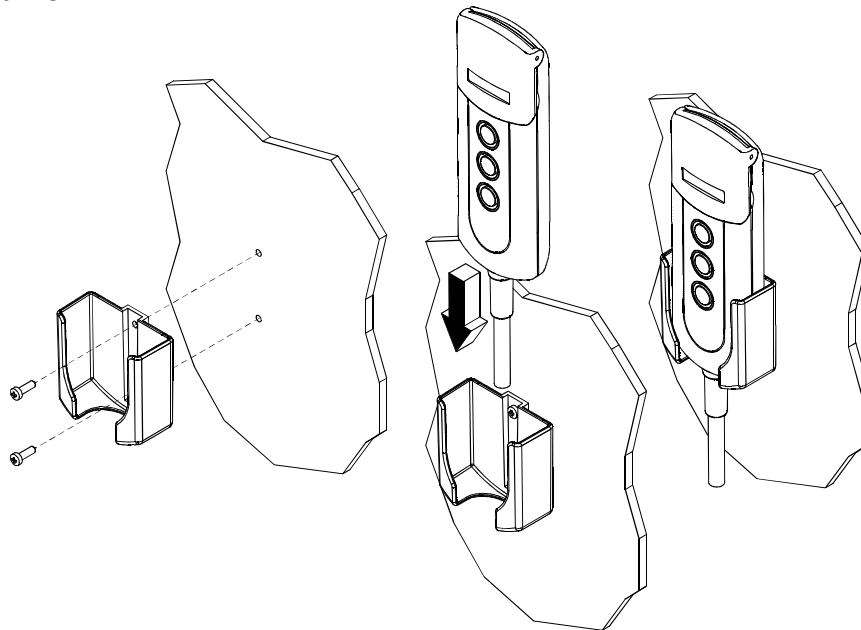

- Drill on the dashboard one hole of 20.5 mm (~13/16") and 4 holes of 2.2 mm (~3/32") to fasten the connector tap.
- Put the gasket between the rear part of tap and the dashboard.
- The rear part must be protected from contact with water or moisture.
- For instructions on making electrical connections, see the attached diagram. The wires must have a minimum cross section size of 1.5 mm<sup>2</sup>.
- Install a 3 A (ampere) fast safety fuse on the + wire of the battery. Do not use the voltage generated by the engine battery set to provide power.
- The instrument complies with EMC standards (EN55022) and must be positioned at a distance of:
  - 30 cm (~1 Ft) from the compass;
  - 50 cm (~1.5 Ft) from radio

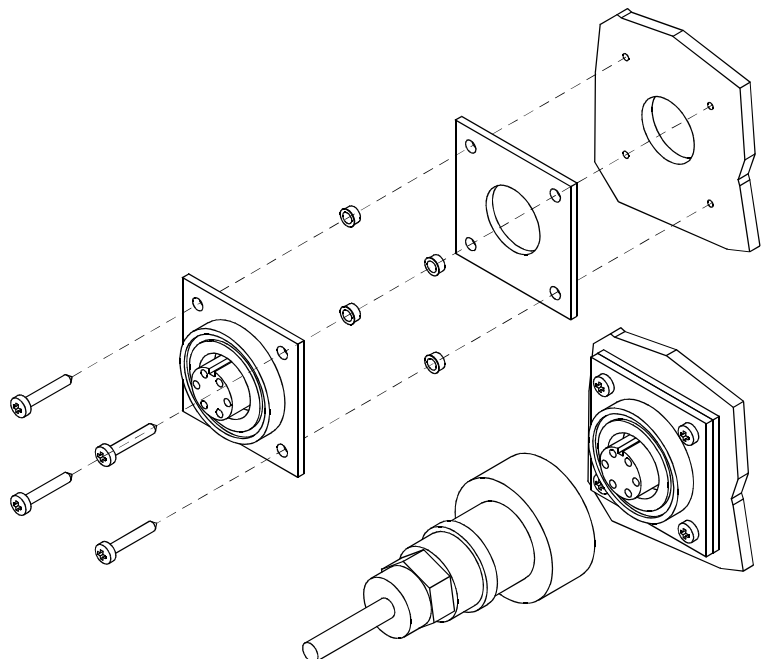

- equipment;
- 2 metres (~6.5 Ft) from radio transmitter equipment;
  - 2 metres (~6.5 Ft) from the radar beam.

## Connections

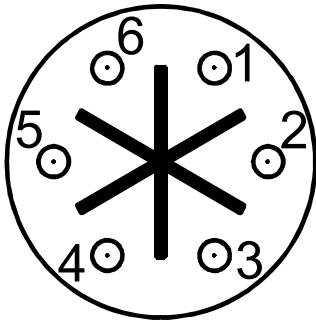

6-POLE REAR CONNECTOR	
PIN	SIGNAL
1	- battery
2	+ battery
3	DOWN command
4	UP command
5	Magnetic sensor
6	

## Connector and sensor holes

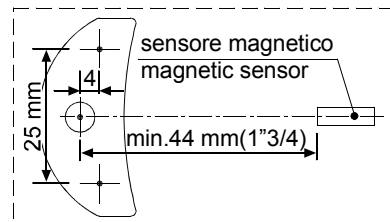
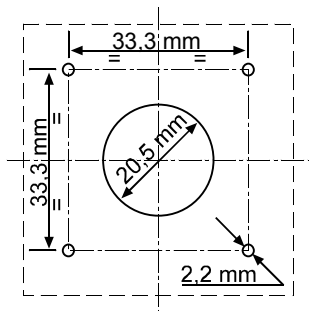

## Starting up

The chain counter features a graphic display and three keys: **⏻ (ON)**, **⏮ (UP)** and **⏭ (DOWN)**. There is also a buzzer that indicates the pressing of the keys or attracts the user's attention in particular conditions (alarm triggering).

The **ON** key switches on the display and enables the other two keys. It must be used to access the parameter setting menus. For selecting the parameters to be modified and to confirm the values set. The display backlight will switch off 30 seconds after the last command given (adjustable default time – see “BkLight Time”).

The **UP** key commands the hoisting of the anchor and the **DOWN** key casts it. When the key is released, the action is stopped. During parameter setting, the two keys allow the User to move around the menu and vary parameter values.

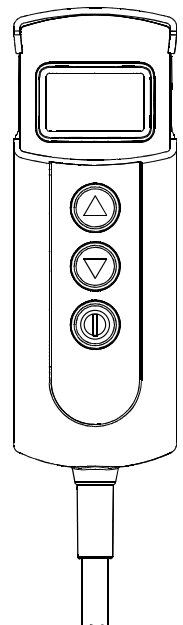

When switched on, the instrument will make a beep and the following page will appear for a few seconds:



Once the initialisation procedure is complete, the main page will appear.

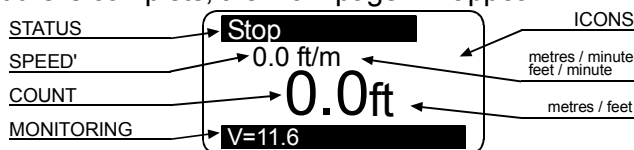

Where:

**STATUS:** indicates the status of the instrument and any failure.

**SPEED':** indicates the chain speed during hoisting or lowering in meters per minute or feet per minute.

**COUNT:** indicates the measurement of the chain lowered (in metres or feet).

**MONITORING:** indicates the power supply voltage.

**ICONS:** this is the part of the *display* bearing the icons that indicate the hoisting or casting of the anchor and any failure.

When the instrument is turned on for the first time, it will set up as programmed in the factory (see table).

Parameter	Default value
Up Alarm	3.0 metres
Auto Down	Off
BackLight Time	30 seconds
Units of measurement	Metres/centimetres
Chain Measure	0.0 metres
Barbotin Circumference	33 cm
Sensor type	unknown
Keyboard Beep	Yes
Language	Italian
Works Hours	0
Division factor	1

## Chain counter setting menu

<p>Hold down the <b>Ⓜ</b> (<b>ON</b>) key for six seconds to access the instrument setting menu. The following page will appear on the display:</p>	
<p>Use the <b>Ⓣ</b> (<b>DOWN</b>) and <b>Ⓢ</b> (<b>UP</b>) keys to move around the menu options.</p>	
<p>Once you are positioned on the item to be modified press the <b>Ⓜ</b> (<b>ON</b>) key to confirm your choice.</p>	
<p>Use the <b>Ⓣ</b> (<b>DOWN</b>) or <b>Ⓢ</b> (<b>UP</b>) keys to move from one parameter to another.</p>	
<p>Once one is positioned on the parameter press the <b>Ⓜ</b> (<b>ON</b>) key to enable modification.</p>	
<p>According to the type of parameter, using the <b>Ⓣ</b> (<b>DOWN</b>) and <b>Ⓢ</b> (<b>UP</b>) keys it is possible to reduce/increase the value of the same or disable/enable the function.</p>	

Once the modification has been performed, press the **⏏** (**ON**) key to confirm.

Using the **⏴** (**DOWN**) key go to the **Exit** option and press the **⏏** (**ON**) key again to return to the setting menu. The same procedure must be used to return to the main page.







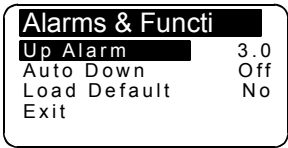



### Measurement menu

	
Use the <b>⏴</b> ( <b>DOWN</b> ) or <b>⏵</b> ( <b>UP</b> ) key to move around the parameters.	
<b>Reset Measurement</b> Resets the chain measurement value (0.0).	Select with <b>⏏</b> <b>⏴</b> = Yes <b>⏵</b> = No Confirm with <b>⏏</b>
<b>Units</b> Selects the unit of measurement: Feet/ inches Metres / centimetres	Select with <b>⏏</b> <b>⏵</b> = Feet <b>⏴</b> = Metres Confirm with <b>⏏</b>
<b>Exit</b> To return to the settings menu.	Confirm with <b>⏏</b>











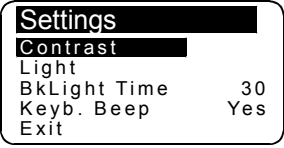









### Alarm and functions menu

	
Use the <b>⏴</b> ( <b>DOWN</b> ) or <b>⏵</b> ( <b>UP</b> ) key to move around the parameters.	
<b>Up Alarm</b> It is possible to enable the function and establish the height at which the anchor-winch stops; after which it is only possible to give pulsed commands. Settable values: 1.0 - 1.5 - 2.0...5.0 (metres or feet).	Select with <b>⏏</b> Select value with <b>⏵</b> <b>⏴</b> Confirm with <b>⏏</b>



<p><b>Auto Down</b> Enables the automatic anchor lowering procedure, at the desired height, with the pressing (for at least 3 seconds) of the keys  and .</p> <p>Settable value: 5 - 10 - 15...40 (metres or feet).</p>	<p>Select with </p> <p>Select value with  </p> <p>Confirm with </p>
<p><b>Load Default</b> This function allows the User to revert to the original factory default settings, <u>thus erasing all settings memorised</u>.</p> <p><b>This command must only be used in the event of programming errors.</b></p>	<p>Select with </p> <p> = Yes    = No</p> <p>Confirm with </p>
<p><b>Exit</b> To return to the settings menu.</p>	<p>Confirm with </p>

### Settings menu



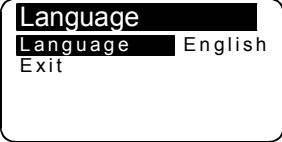

	
<p>Use the  (<b>DOWN</b>) or  (<b>UP</b>) key to move around the parameters.</p>	
<p><b>Contrast</b> By enabling this function it is possible to start the display contrast programming procedure.</p>	<p>Select with </p> <p>Select value with  </p> <p>Confirm with </p>
<p><b>Light</b> By enabling this function it is possible to start the display luminous intensity programming procedure.</p>	<p>Select with </p> <p>Select value with  </p> <p>Confirm with </p>
<p><b>BackLight Time</b> This function allows the user to set the backlight on time during which the display remains lit after the last command given (default value 30 seconds).</p>	<p>Select with </p> <p>Select value with  </p> <p>Confirm with </p>
<p><b>Keyboard Beep</b> This function allows the user to enable or disable the buzzer (emitted each time a key is pressed).</p>	<p>Select with </p> <p> = No    = Yes</p> <p>Confirm with </p>
<p><b>Exit</b> To return to the settings menu.</p>	<p>Confirm with </p>

## Language menu

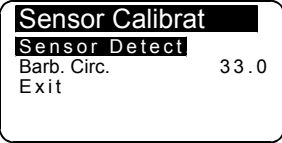
	
<p>Use the <math>\nabla</math> (DOWN) or <math>\triangle</math> (UP) key to move around the parameters.</p>	
<p><b>Language</b> The user may select the display language: Italian, English, French, German, Spanish</p>	<p>Select with <math>\textcircled{1}</math> Select value with <math>\triangle</math> <math>\nabla</math> Confirm with <math>\textcircled{1}</math></p>
<p><b>Exit</b> To return to the settings menu.</p>	<p>Confirm with <math>\textcircled{1}</math></p>

## Sensor calibration menu

	
<p>Use the <math>\nabla</math> (DOWN) or <math>\triangle</math> (UP) key to move around the parameters.</p>	
<p><b>Sensor Detect</b> This function has the purpose of calibrating the instrument according to the type of sensor installed (Standard or Project). The second screen indicates the time for a sensor period and type.</p>	<p>Select with <math>\textcircled{1}</math></p> <div style="border: 1px solid black; padding: 5px; margin: 10px auto; width: 80%;"> <p><b>Sensor Detect.</b> Press Up/Down Key to run the motor</p> </div>
<p>Press <math>\triangle</math> or <math>\nabla</math></p>	
<div style="border: 1px solid black; padding: 5px; margin: 10px auto; width: 80%;"> <p><b>Sensor Detect</b> Press Up/Down Key to run the motor 0.400 sec. Sensor:Std</p> </div>	<div style="border: 1px solid black; padding: 5px; margin: 10px auto; width: 80%;"> <p><b>Sensor Detect</b> Press Up/Down Key to run the motor 0.400 sec. Sensor:Proj.</p> </div>
<p>Confirm with <math>\textcircled{1}</math></p>	
<p>Once the “Sensor Detection” function has recognised a “Standard” type sensor instead of a “Project” sensor, when the “Sensor Calibrat.” menu is entered again, the menu options will “configure” themselves according to the sensor detected.</p>	

<p style="text-align: center;"><b>Standard and X.. Project series sensor menu</b> (magnet and sensor placed <u>on barbotin</u>)</p> <div style="border: 1px solid black; padding: 5px; margin: 10px auto; width: fit-content;"> <p style="text-align: center; margin: 0;"><b>Sensor Calibrat</b></p> <p style="margin: 0;">Barb. Circ. 33.0</p> <p style="margin: 0;">Divisor fact. 1</p> <p style="margin: 0;">Exit</p> </div>	<p style="text-align: center;"><b>1000 – 1500 – 2000 W Project series sensor menu</b> (magnet and sensor placed <u>on motor</u>)</p> <div style="border: 1px solid black; padding: 5px; margin: 10px auto; width: fit-content;"> <p style="text-align: center; margin: 0;"><b>Sensor Calibrat</b></p> <p style="margin: 0;">Red. Factor 57.0</p> <p style="margin: 0;">Exit</p> </div>
<p><b>Barbotin Circumference</b> In this row the user must enter the circumference of the gypsy (in centimetres or inches). Use the <b>Table 1</b> provided to calculate the circumference. Settable values: centimetres or inches. Default value, 33 cm.</p> <p><b>Division Factor</b> If you use the 3-wire inductive sensor set here the number of signatures of the gypsy obtained from <b>Table 1</b>. If you use the 2-wire magnetic sensor leave the value set to <b>1</b>.</p>	<p><b>Reduction Factor</b> In this row the user must enter the reduction factor. See next <b>Table 2</b> for the correct value to be entered Default value, 57.</p>
<p>Select with </p> <p>Select value with  </p> <p>Confirm with </p>	
<p><b>Exit</b> To return to the settings menu.</p>	<p>Confirm with </p>

**Table 1 - Standard and Project X.. series sensor  
(magnet and sensor placed on barbotin)**

Chain Type	Number of recesses	Gipsy Circumference (cm)	Gipsy Circumference (inches)
6 mm	6	22	9
	9	34	13
7 mm	6	25	10
8 mm	5	24	9
	6	28	11
	7	33*	13
	8	38	15
10 mm	5	31	12
	6	36	14
12 mm	5	36	14
	6	43	17
13 mm	6	46	18
14 mm	5	42	16



\* factory settings of instrument

**Table 2 - 1000 – 1500 – 2000W Project series sensor  
(magnet and sensor placed on motor)**

Type	Gipsy Circumfer. (cm)	Reduction ratio	Number of recesses	Chain type (mm-inches)	Reduction Factor
Project 1000	30	1:52	6	8-5/16"HT	57*
	30	1:52	5	10 DIN 766	
	31	1:52	5	10 ISO-3/8"HT	59
	34	1:52	9	6	65
Project 1500	30	1:70	6	8-5/16"HT	43
	30	1:70	5	10 DIN 766	43
	31	1:70	5	10 ISO-3/8"HT	44
	36	1:70	5	12 ISO-13 DIN 766-7/16"HT	51
Project 2000	39	1:75	6	3/8"HT	52
	40	1:75	6	3/8"Proof Coil	53
	41	1:75	6	10 DIN 766-3/8"BBB	54
	44	1:75	7	10 ISO	58
	45	1:75	5	14 ISO	60
	46	1:75	6	12 ISO-13 DIN 766	61
	47	1:75	5	13 DIN 764	63

\* factory setting of instrument

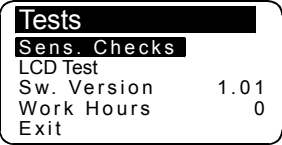
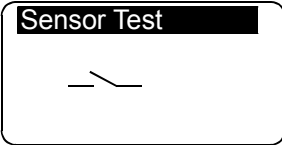
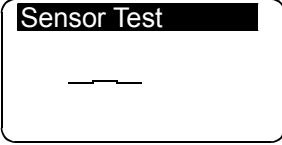
## Check menu

	
Use the ⏴ (DOWN) or ⏵ (UP) key to move around the parameters.	
<p><b>Sensor Checks</b> The purpose of this function is to check the state of the sensor:</p> <p style="text-align: center; margin: 20px 0;">contact open</p> <p style="text-align: center; margin: 20px 0;">contact closed</p>	<p>Select with ⏴</p> <div style="border: 1px solid black; padding: 5px; margin: 5px 0;">  </div> <div style="border: 1px solid black; padding: 5px; margin: 5px 0;">  </div> <p>Confirm with ⏴</p>
<p><b>LCD Test</b> This function switches on all the display's pixels thus making it possible to perform a check on them.</p>	<p>Select with ⏴</p> <div style="border: 1px solid black; padding: 5px; margin: 5px 0;">  </div> <p>Confirm with ⏴</p>
<p><b>Software Version</b> Indicates the version of the software installed.</p>	
<p><b>Work Hours</b> Indicates the hours of operation of the winch.</p>	
<p><b>Exit</b> To return to the settings menu.</p>	<p>Confirm with ⏴</p>

## Instrument calibration

Before using the instrument the following parameters must be set:

- choice of unit of measurement (metres or feet);
- detection of type of sensor (Standard or Project);
- gipsy diameter setting (default value 33 cm) or reduction factor (default value 57).

### Standard and X.. Project series sensor menu

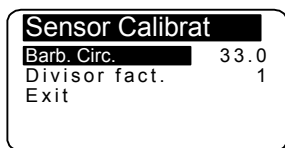

### 1000 – 1500 –2000 W Project series sensor menu

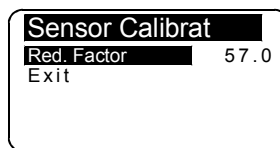

## Use

Press the **(ON)** key to activate controls and to switch on the display lighting. The *display* lighting switches off 30 seconds after the last command given (adjustable *default* time – see “BkLight Time”).

Press key **(UP)** to control the anchor ascending.

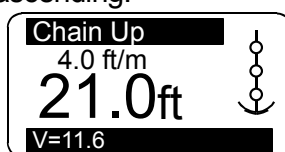

Press key **(DOWN)** to cast anchor.

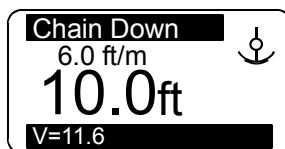

When any key is released (**UP** or **DOWN**) the corresponding action is stopped.

## Measurement reset

To reset the measurement count simultaneously press the **(ON)** and the **(UP)** keys for at least three seconds.

Measurement reset may also be performed in the **Measurement** menu by selecting “Yes” in the **Reset Measure** row.



## Automatic casting of the anchor

This function must be enabled in the **Alarms and Functions** menu (disabled by default).

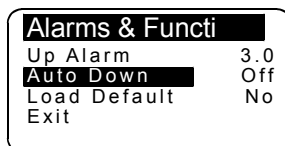

Select the row “**Auto Down**” and set the value at which the anchor must stop. Then press the **(ON)** and **(DOWN)** keys for at least three seconds. Once anchor casting has commenced, release the keys. **For safety reasons it is however possible to interrupt automatic descent by pressing any instrument key.**

## Troubleshooting

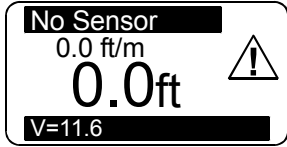
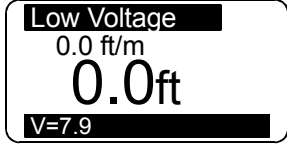
FAULT	CAUSE	CORRECTIVE ACTION
	<p>Though <b>UP</b> or <b>DOWN</b> keys are pressed, the instrument doesn't receive any signal from the magnetic sensor for more than 5 seconds.</p>	<p>Check the sensor electric connections.</p> <p>Check if sensor operates properly. If not, replace it.</p> <p>Check the position of sensor and magnet on gipsy and their distance (3 mm).</p> <p>Check the operation of electric installation or anchor windlass.</p>
	<p>The instrument's power supply voltage is lower than 10V.</p>	<p>Verify the battery charge or operation of the electrics system.</p>

## Warranty

We guarantee our products from manufacturing defects for 2 years from the purchase date (purchase ticket or any other purchase proof will be requested). Guarantee does not include damages and breakage during the transport, damages and breakage due to faulty installation or improper use. Warranty is no longer valid when repairs or servicing have been made by unauthorized people or made with spare parts which are not original. Warranty does not include the complete replacement of the goods and refers exclusively to the replace of faulty pieces and necessary labour. It does not include transfer or transport expenses. The Customer will not ask for expenses refund.

# SCHEMA ELETTRICO / ELECTRICAL DRAWING

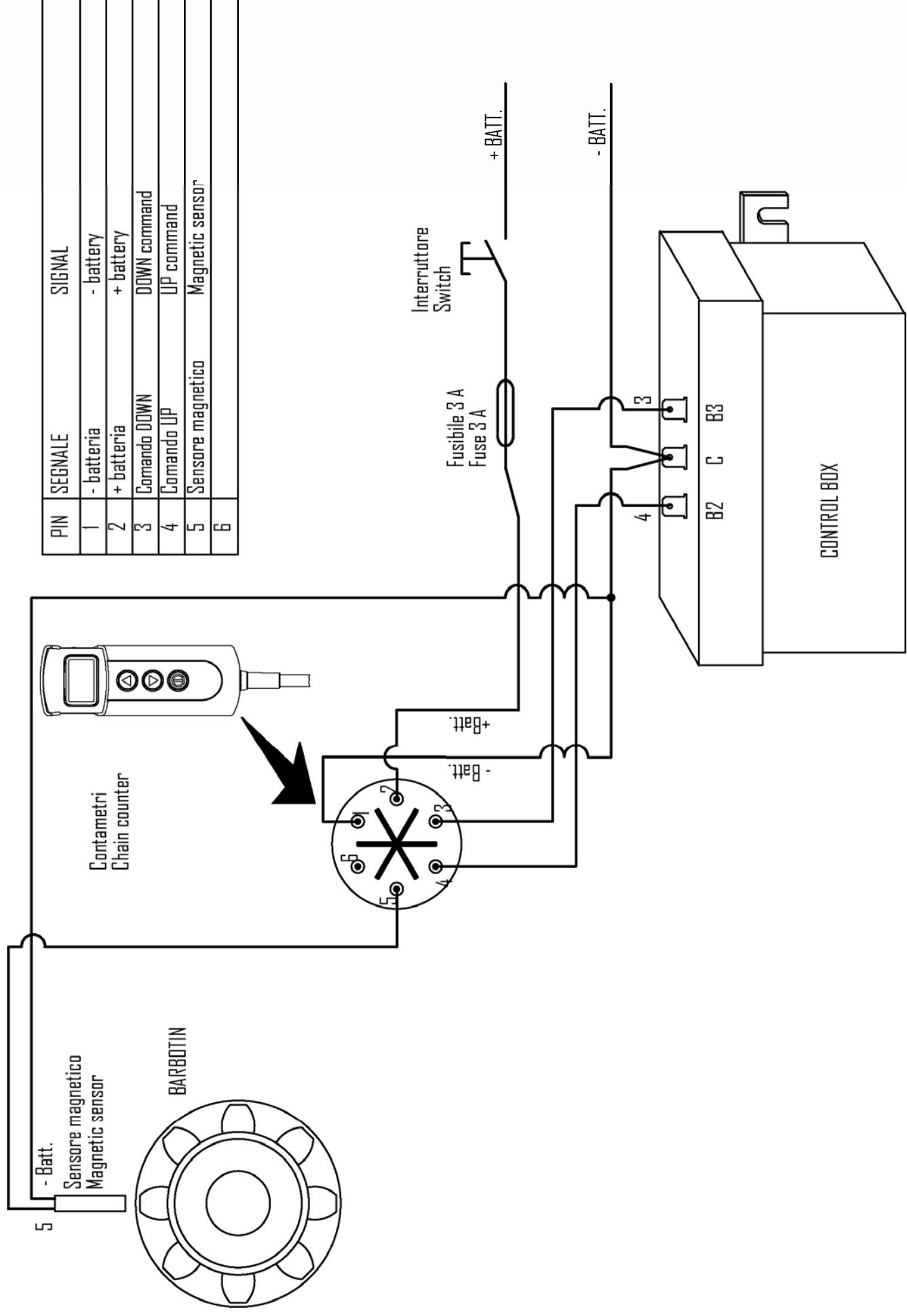



# SCHEMA ELETTRICO / ELECTRICAL DRAWING

## Sensore induttivo / Inductive sensor

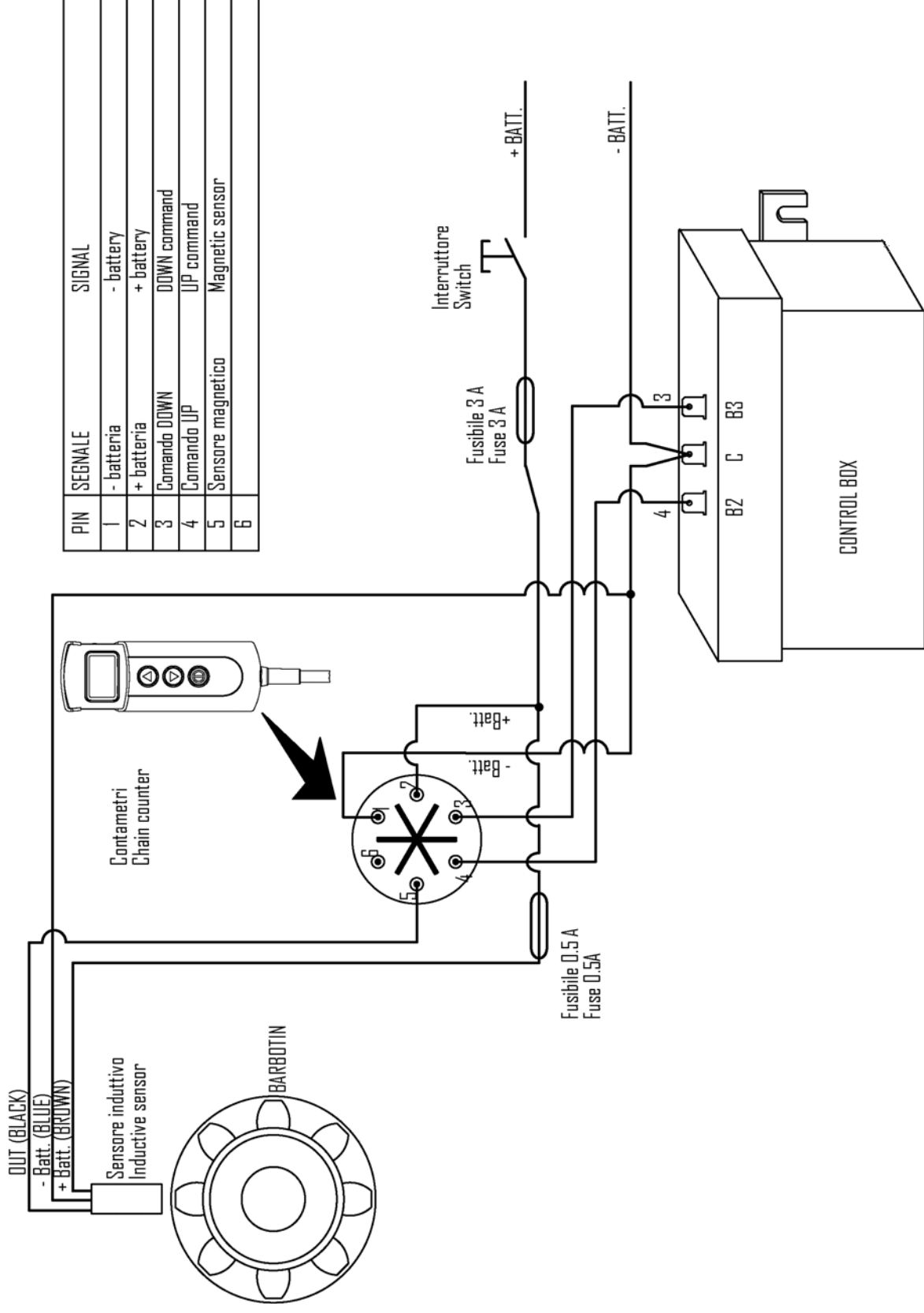

NOTA: Impostare il "Fattore di divisione" per un corretto funzionamento del sensore (vedere menù Calibrazione Sensore)

NOTE: Set the "Division Factor" parameter in order to get a correct chain length (see the "Sensor Calibration" menù)