

Installation Guide

For S-Link Automatic Main Switch
897712, 897724



SLEIPNER MOTOR AS

P.O. Box 519

N-1612 Fredrikstad

Norway

www.sleipnergroun.com

DOCUMENT ID: 442I

REVISION: 6

DATE: 2022

LANGUAGE: EN

MI

Contents

Installation Manual

Responsibility of the installer.....	3
Considerations and Precautions.....	3
Measurements	4
Automatic Main Switch	5
AMS Installation.....	6
S-link System Description	7
Electrical Installation.....	8
Technical Wiring Diagram	9
Service.....	10
Service and Support.....	11
Product Spare Parts and Additional Resources.....	11
Warranty Statement.....	11

Products

897724 - Automatic main switch 24V S-link
897712 - Automatic main switch 12V S-link



Sleipner Motor AS
P.O. Box 519, Arne Svendsensgt. 6-8
N-1612 Fredrikstad, Norway

MC_0020

Failure to follow the considerations and precautions can cause serious injury, damage and will render all warranties given by Sleipner Motor as VOID.

MC_0411

Responsibility of the Installer

MC_0038

The installer must read this document to ensure necessary familiarity with the product before installation.

Instructions in this document cannot be guaranteed to comply with all international and national regulations. It is the responsibility of the installer to follow all applicable international and national regulations when installing Sleipner products.

The recommendations given in this document are guidelines ONLY, and Sleipner strongly recommends that advice is obtained from a person familiar with the particular vessel and applicable regulations.

This document contains general installation instructions intended to support experienced installers. If you are not skilled in this type of work, please contact professional installers for assistance.

If required by local regulation, electrical work must be done by a licensed professional.

Appropriate health and safety procedures must be followed during installation.

Faulty installation of Sleipner products will render all warranties given by Sleipner Motor AS.

General Installation Considerations and Precautions Guidelines

MC_0440

For Sleipner automatic main switch

MC_0273

- Install the automatic main switch as close to the battery(ies) as possible.
- Do not connect the Sleipner automatic main switch with other products than appropriate original Sleipner control panels or other SLEipner control devices. **(NB: Sleipner products are specifically designed with a separate fifth control cable for the automatic main switch.)**
- The automatic main switch must be installed so that it keeps dry at all times.
- The automatic main switch can NOT be fitted in spaces requiring Ignition protected equipment.
- Ensure to use the correct fuse for the main switch depending on the thruster model installed.

IMPORTANT

This manual is to be used in addition to the regular installation manual for the Sleipner thruster. This manual is intended for professionals only.

When installing an S-Link™ system DO NOT connect any other control equipment directly to the S-Link™ bus except original Sleipner S-Link™ products. In case of connecting third-party equipment, it must always be connected through a Sleipner-supplied interface product.

Any attempt to directly control or connect into the S-Link™ control system without a designated and approved interface will render all warranties and responsibilities of all of the connected Sleipner products.

If you are interfacing the S-Link™ bus by agreement with Sleipner through a designated Sleipner supplied interface, you are still required to install at least one original Sleipner control panel to enable efficient troubleshooting if necessary.

MC_0105

Measurement code	Measurement description	AMS	
		mm	inch
H	Height	194.3	7.6
L	Length	205	8.1
W	Width	79	3.11
+ W	Width including fasteners	90	3.54
(a)	Attachment hole from the top	51.5	2.03
(b)	Attachment hole from the bottom	92.8	3.65
(c)	Attachment hole from the side	37.5	1.5
(d)	Distance between attachment hole	121.8	4.8
(e)	Attachment hole from the side	45.7	1.8

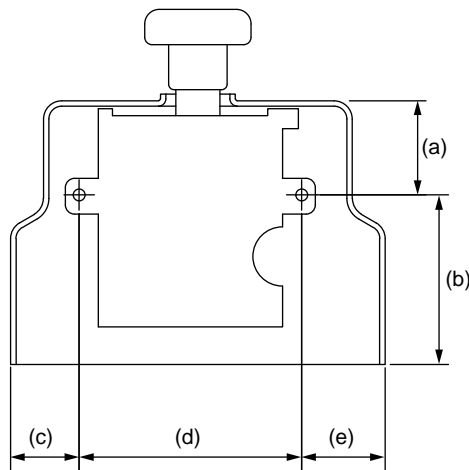
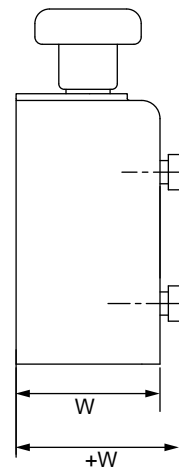
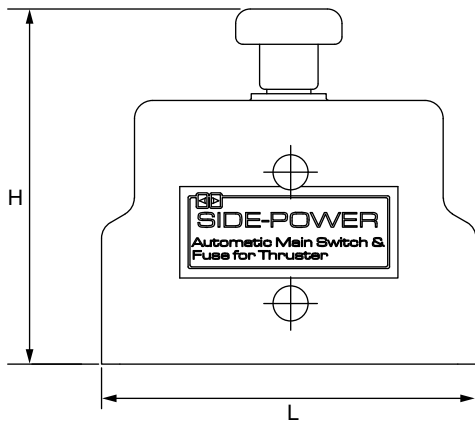

Automatic Main Switch

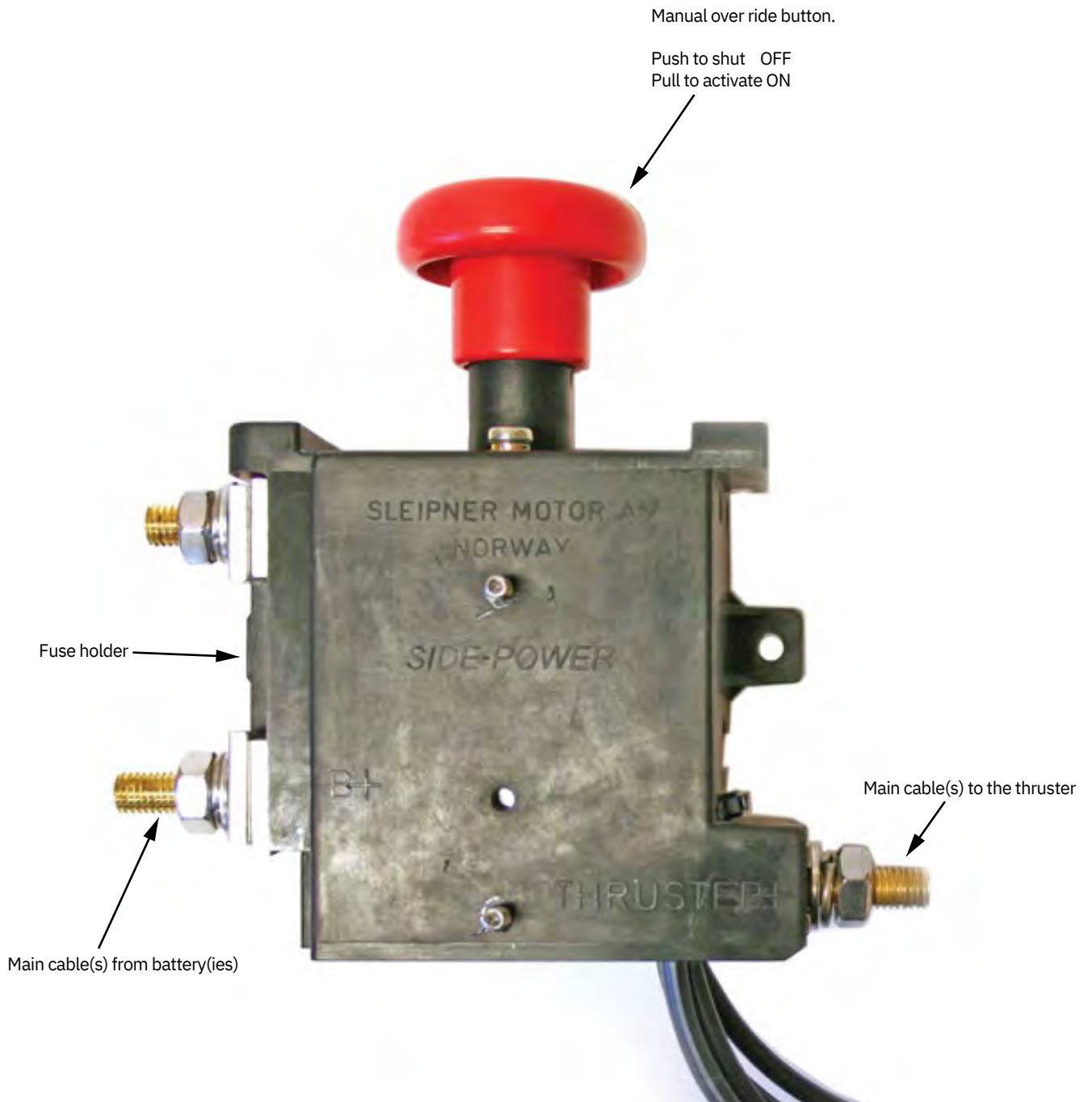

! Please refer to the graphic for special considerations relating to your model !

Installing the fuse and battery cables.

1. Remove the nuts and all the washers.
2. Install the fuse on top of the pre-fitted conductors and washer.
3. Assemble the washers, battery cables and end washer and nuts.
4. Tighten the end nut to torque as shown above. **(NB: Be cautious tightening the brass conductors as they are softer than steel bolts.)**

Fitting the thruster cables.

5. Remove the nuts and washers.
6. Fit the cable/ cables as shown directly onto the pre-fitted conductor.
7. Assemble the washers in the sequence shown.
8. Tighten the end nut.

Manual override button.

9. Pull OUT for ON.
10. Push IN for OFF.
11. Leave the switch in ON position when on-board.
12. Ensure the switch is in the OFF position when leaving the boat for long periods or when installing or servicing the thruster system.

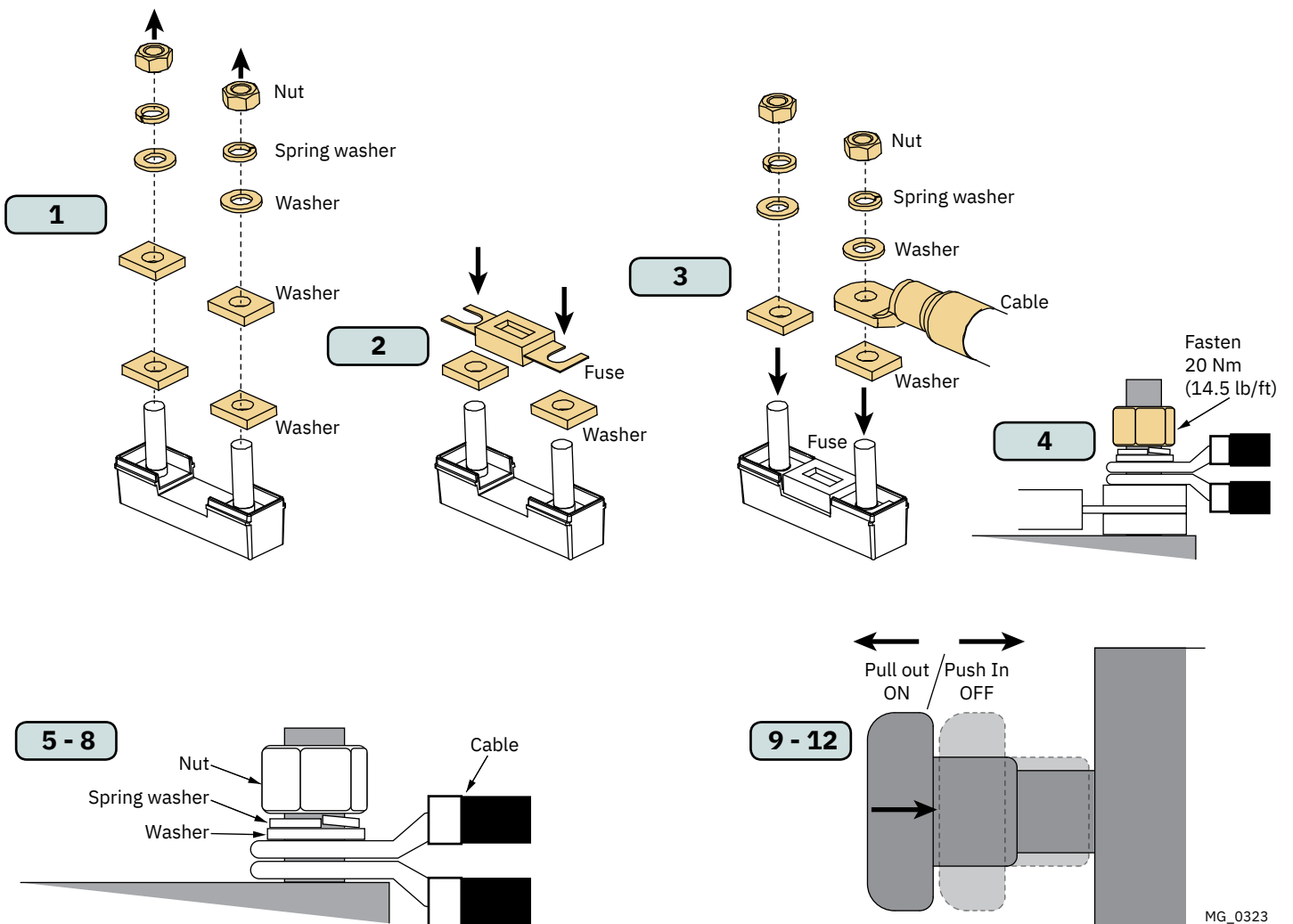

MG_0323

S-Link is a CAN-based control system used for communication between Sleipner products installed on a vessel. The system uses BACKBONE Cables as a common power and communication bus with separate SPUR Cables to each connected unit. Units with low power consumption are powered directly from the S-Link bus therefore one power cable must be connected to the BACKBONE Cable through a T-Connector.

Main advantages of S-Link system:

- Compact and waterproof plugs.
- BACKBONE and SPUR Cables have different colour coding and keying to ensure correct and easy installation. BACKBONE Cables have blue connectors and SPUR Cables have green connectors.
- Different cable lengths and BACKBONE Extenders makes the system scalable and flexible to install.

Installation of S-Link cables:

Select appropriate cables to keep the length of BACKBONE- and SPUR Cables to a minimum. In case of planned installation with total BACKBONE Cable length exceeding 100 meters please consult your local distributor. The S-Link cables should be installed to ensure sharp bend radius's is avoided. Locking mechanism on connectors must be fully closed. To ensure long lifetime, cables, T-Connectors and Extenders should not be located so that they are permanently immersed in water or other fluids. It is also recommended to install cables such that water and condensation do not run along the cables and into the connectors.

The POWER Cable should ideally be connected around the middle of the BACKBONE Cable to ensure an equal voltage drop at each end of the BACKBONE Cable. The yellow and black wire in the POWER Cable shall be connected to GND and the red wire connected to +12VDC or +24VDC.

To reduce the risk of interference, avoid routing the S-Link cables close to equipment such as radio transmitters, antennas or high voltage cables. The backbone must be terminated at each end with the END Terminator.

SPUR cables can be left unterminated to prepare for the installation of future additional equipment. In such cases, ensure to protect open connectors from water and moisture to avoid corrosion in the connectors.

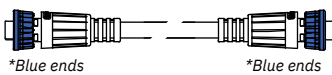

BACKBONE Cable

Forms the communication and power bus throughout a vessel. Available in different standard lengths.

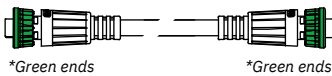

SPUR Cable

Used to connect S-Link compliant products to the backbone cable. One SPUR Cable must be used for each connected component, with no exceptions. Recommended to be as short as practically possible. Available in different standard lengths.

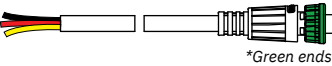

POWER Cable

Required in all installations for connection of BACKBONE Cable to a power supply. It shall not be more than one POWER Cable in an installation.

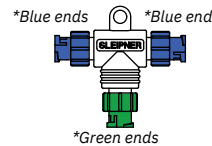

T-Connector

Used for connection of SPUR or POWER Cable to the BACKBONE Cable. One T-Connector for each connected cable.

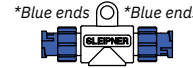

BACKBONE Extender

Connects two BACKBONE Cables to extend the length.

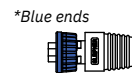

END Terminator

Must be one at each end of the BACKBONE bus.

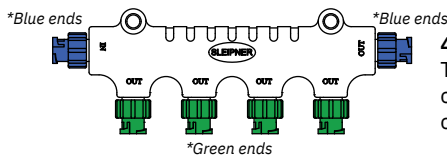

4-Port T-Connector

The 4-PORT T-connector allows multiple SPUR Cables to be connected. The 4-PORT T-connector comes with two sealing caps to protect unused ports.

S-Link installation example

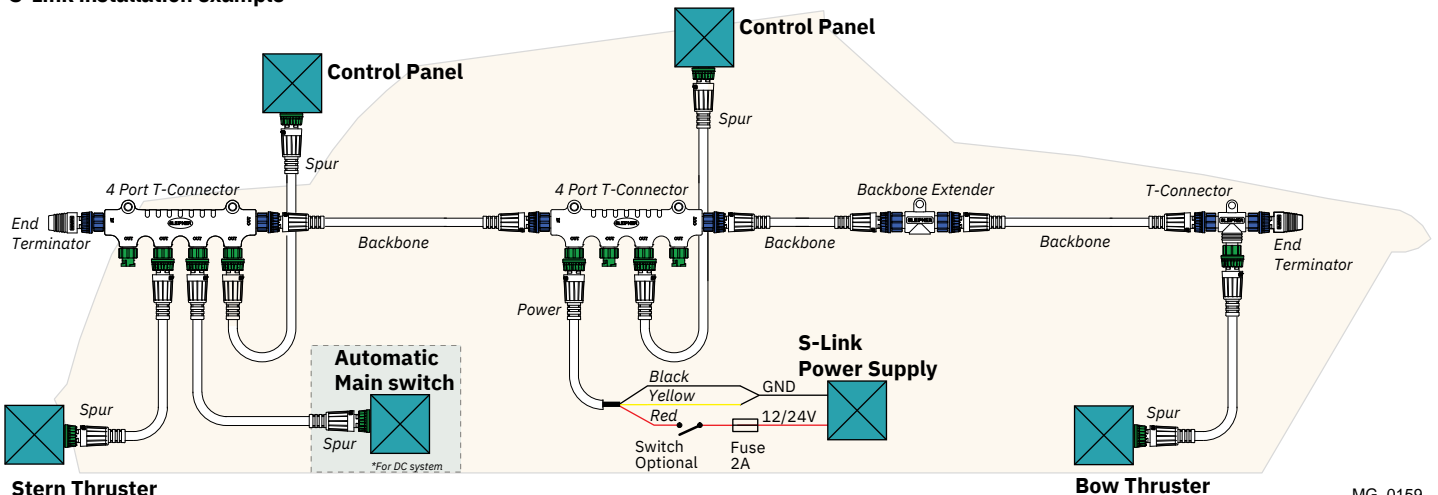

! Please refer to the graphic for special considerations relating to your model !

ON/ OFF configuration

Use a 4-lead control cable between the thruster and the automatic main switch. **(NB: Only 3 leads are used, The red wire is not connected into the automatic main switch.)**

Proportional configuration

Use 5-lead control cables between the automatic main switch and control panels. **(NB: use 5-lead Y-connectors to branch off to all controls fitted.)**

Refer to the table in the thrusters manual for deciding the main cable sizes, the lengths are the total of positive and negative from the battery.

WARNING

Check the following with the main switch is set to off :
After all electrical connections have been completed check with an ohm meter that there is no electrical connection between
1. electro-motor flange and the positive terminal on the motor
2. electro-motor flange and the battery negative terminal on the motor

If unsure contact skilled personnel.

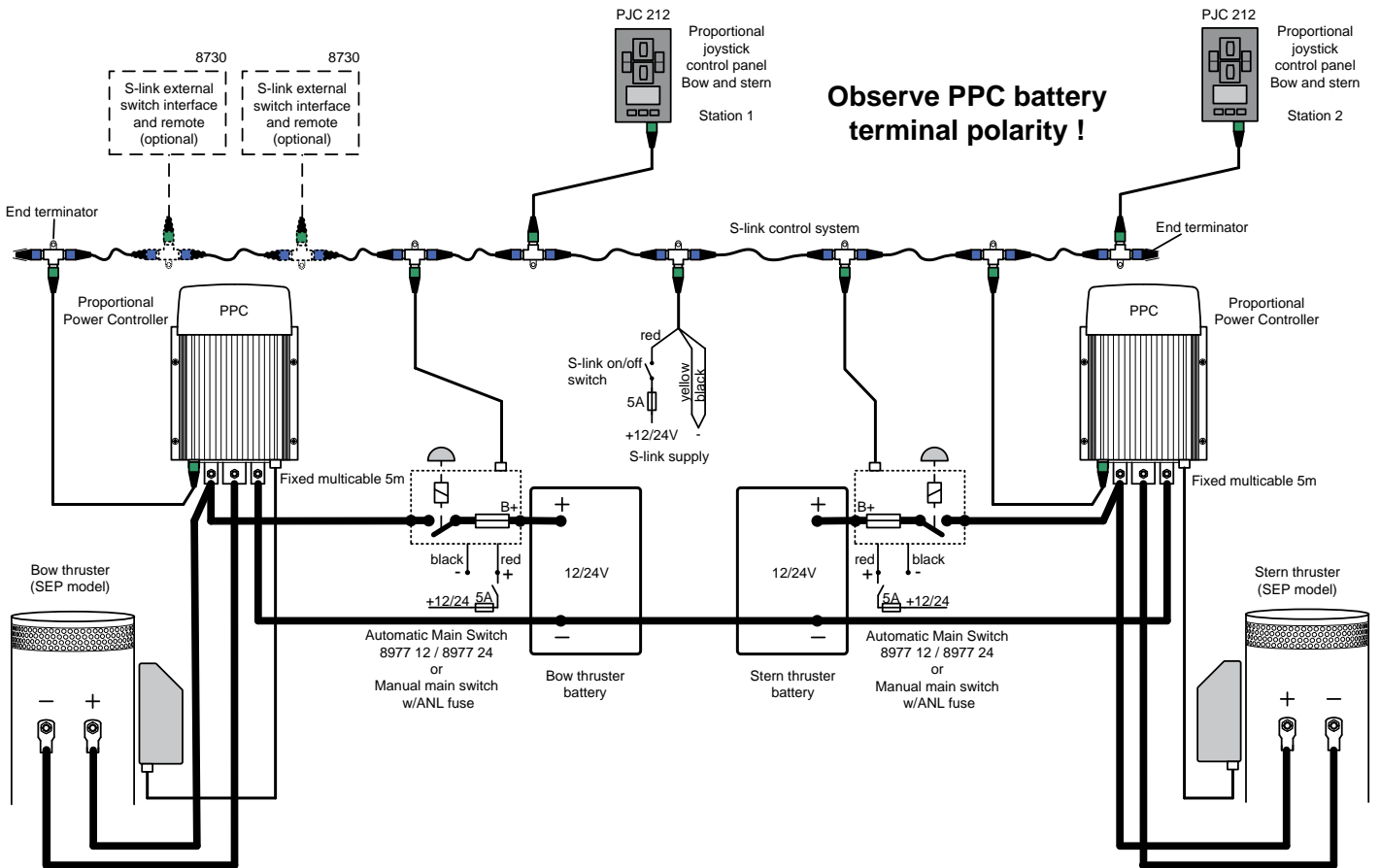

MG_0328

Technical Wiring Diagram

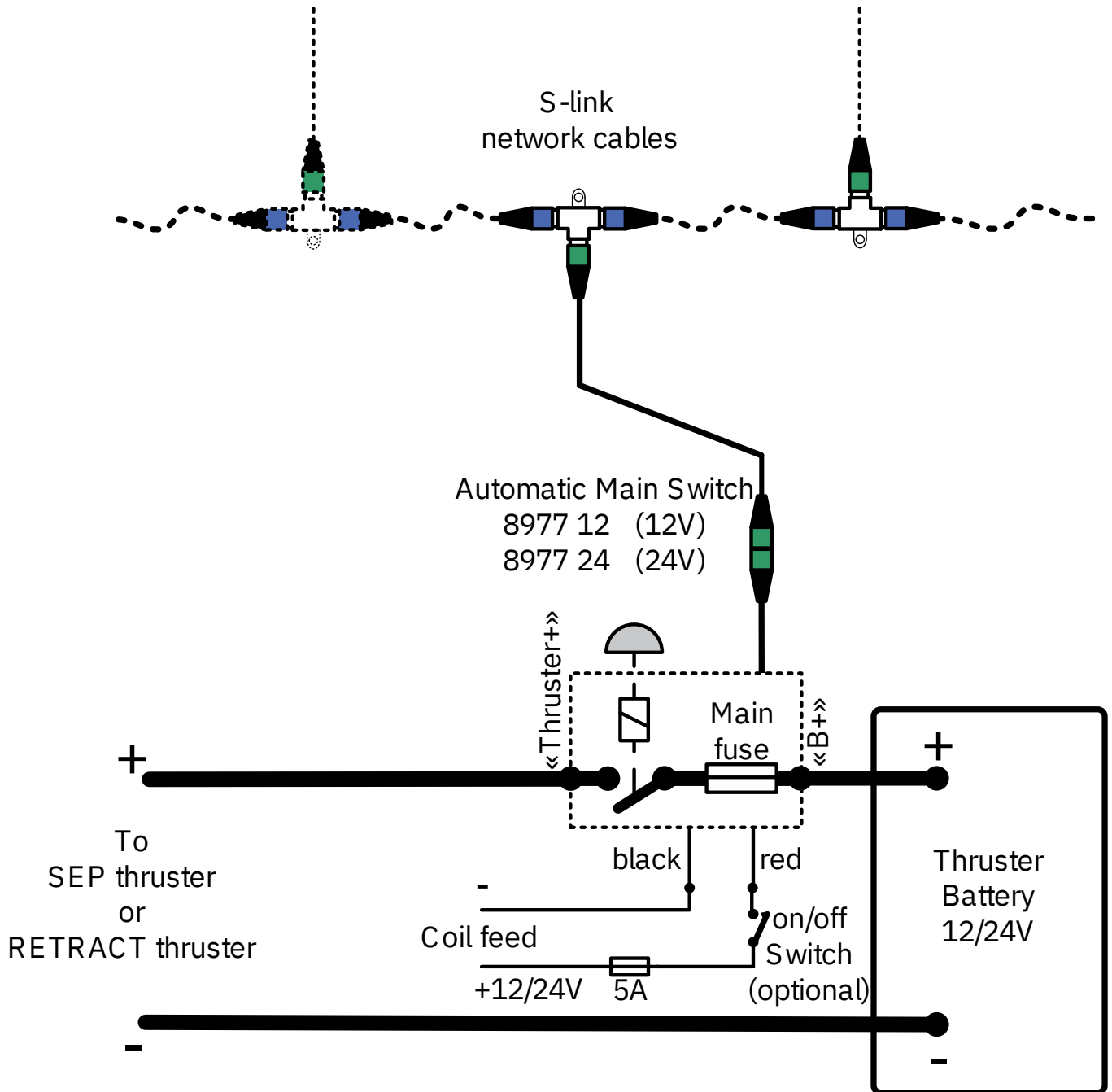

DESCRIPTION OF WIRING DIAGRAMS:

- Install the correct main fuse depending on thruster model fitted.
- Coil feed can be taken from any 12V or 24V battery source. If the coil is fed from a source that already has a main switch, an on/off switch is not required.
- The S-Link cable must be connected to the S-Link network on the Automatic Main Switch assigned to be bow or stern

IMPORTANT
Fit only one thruster to each automatic main switch.

! Please refer to the graphic for special considerations relating to your model !

Service/ maintenance

on all-electric equipment regularly Ensure:

- Equipment is clean and dry.
- Ensure all cable and other connections are tight and without signs of excessive heat or corrosion.

Troubleshooting

Feedback to control panels:

- Manual override:
 - If the manual override button has been pushed, pull the manual override button to activate.
- Fuse is blown:
 - Replace the fuse or check if the main cable from the battery and main cable to the thruster.
- Communication fail:
 - The panel has no communication with the main switch. Check S-link or power connection.
- Power failure:
 - The main switch has no power, Check 5A fuse, power connection and if the main switch has power on the red and black wire.

Read the troubleshooting guide in the thrusters manual.

If you are unable to identify and resolve the problem, contact the nearest Sleipner service point for assistance. Have the notes from your troubleshooting handy to inform the service person of what you have already checked and observed.

Find your local professional dealer from our certified worldwide network for expert service and support. visit our website www.sleipnergrouper.com/support

Product Spare Parts and Additional Resources

For additional supporting documentation, we advise you to visit our website www.sleipnergrouper.com and find your Sleipner product.

Warranty statement

1. Sleipner Motor AS (The “Warrantor”) warrants that the equipment (parts, materials, and embedded software of products) manufactured by the Warrantor is free from defects in workmanship and materials for purpose for which the equipment is intended and under normal use and maintenance service (the “Warranty”).
2. This Warranty is in effect for two years (Leisure Use) or one year (Commercial and other Non-leisure Use) from the date of delivery/purchase by the end user, with the following exceptions;
 - (a) For demonstration vessels, or vessels kept on the water, the dealer is considered as the end user from 6 months after their launch of the vessel;
 - (b) The warranty period starts no later than 18 months after the first launch of the vessel.
 Please note that the boat manufacturer and dealer must pay particular attention to correct maintenance and service both by the products manuals as well as general good practice for the location the boat is kept in the period the boat is in their care. In cases where the 6 and 18 months grace periods for boat builders and dealers are passed, it is possible to obtain a full warranty upon inspection and approval of the warrantor or such representative.
3. Certain parts, classified as wearable or service parts, are not covered by the warranty. A failure to follow the required maintenance and service work as described in the product manual render all warranty on parts or components directly or indirectly affected by this void. Please also note that for some parts, time is also a factor separately from actual operational hours.
4. This Warranty is transferable and covers the equipment for the specified warranty period.
5. The warranty does not apply to defects or damages caused by faulty installation or hook-up, abuse or misuse of the equipment including exposure to excessive heat, salt or fresh water spray, or water immersion except for equipment specifically designed as waterproof.
6. In case the equipment seems to be defective, the warranty holder (the “Claimant”) must do the following to make a claim:
 - (a) Contact the dealer or service centre where the equipment was purchased and make the claim. Alternatively, the Claimant can make the claim to a dealer or service centre found at www.sleipnergrouper.com. The Claimant must present a detailed written statement of the nature and circumstances of the defect, to the best of the Claimant’s knowledge, including product identification and serial nbr., the date and place of purchase and the name and address of the installer. Proof of purchase date should be included with the claim, to verify that the warranty period has not expired;
 - (b) Make the equipment available for troubleshooting and repair, with direct and workable access, including dismantling of furnishings or similar, if any, either at the premises of the Warrantor or an authorised service representative approved by the Warrantor. Equipment can only be returned to the Warrantor or an authorised service representative for repair following a pre-approval by the Warrantor’s Help Desk and if so, with the Return Authorisation Number visible postage/shipping prepaid and at the expense of the Claimant.
7. Examination and handling of the warranty claim:
 - (a) If upon the Warrantor’s or authorised service Representative’s examination, the defect is determined to result from defective material or workmanship in the warranty period, the equipment will be repaired or replaced at the Warrantor’s option without charge, and returned to the Purchaser at the Warrantor’s expense. If, on the other hand, the claim is determined to result from circumstances such as described in section 4 above or a result of wear and tear exceeding that for which the equipment is intended (e.g. commercial use of equipment intended for leisure use), the costs for the troubleshooting and repair shall be borne by the Claimant;
 - (b) No refund of the purchase price will be granted to the Claimant, unless the Warrantor is unable to remedy the defect after having a reasonable number of opportunities to do so. In the event that attempts to remedy the defect have failed, the Claimant may claim a refund of the purchase price, provided that the Claimant submits a statement in writing from a professional boating equipment supplier that the installation instructions of the Installation and Operation Manual have been complied with and that the defect remains.
8. Warranty service shall be performed only by the Warrantor, or an authorised service representative, and any attempt to remedy the defect by anyone else shall render this warranty void.
9. No other warranty is given beyond those described above, implied or otherwise, including any implied warranty of merchantability, fitness for a particular purpose other than the purpose for which the equipment is intended, and any other obligations on the part of the Warrantor or its employees and representatives.
10. There shall be no responsibility or liability whatsoever on the part of the Warrantor or its employees and representatives based on this Warranty for injury to any person or persons, or damage to property, loss of income or profit, or any other incidental, consequential or resulting damage or cost claimed to have been incurred through the use or sale of the equipment, including any possible failure or malfunction of the equipment or damages arising from collision with other vessels or objects.
11. This warranty gives you specific legal rights, and you may also have other rights which vary from country to country.

Patents

At Sleipner we continually reinvest to develop and offer the latest technology in marine advancements. To see the many unique designs we have patented visit our website www.sleipnergrouper.com/patents

© **Sleipner Group**, All rights reserved
The information given in the document
was right at the time it was published.
However, Sleipner Group cannot
accept liability for any inaccuracies or
omissions it may contain. Continuous
product improvement may change the
product specifications without notice.
Therefore, Sleipner Group cannot accept
liability for any possible differences
between product and document.

**Register your product and learn more
at www.sleipnergroun.com**



SLEIPNER GROUP

P.O. Box 519

N-1612 Fredrikstad

Norway

www.sleipnergroun.com

Made in Norway

